

上面

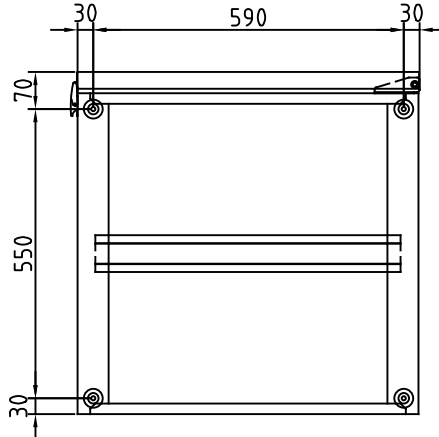

底面

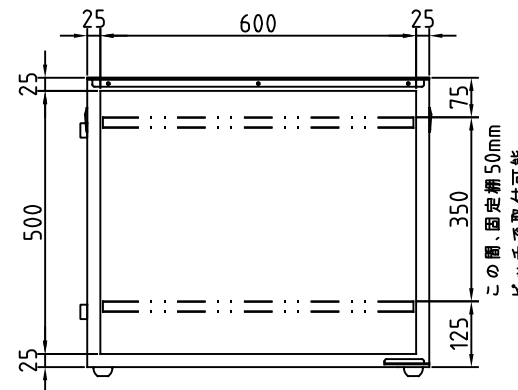

正面(扉を外した時)

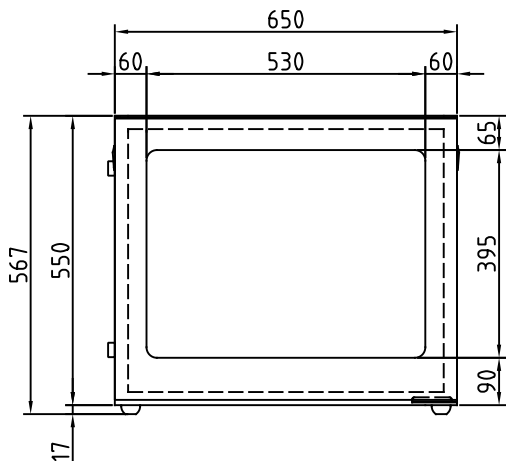

正面

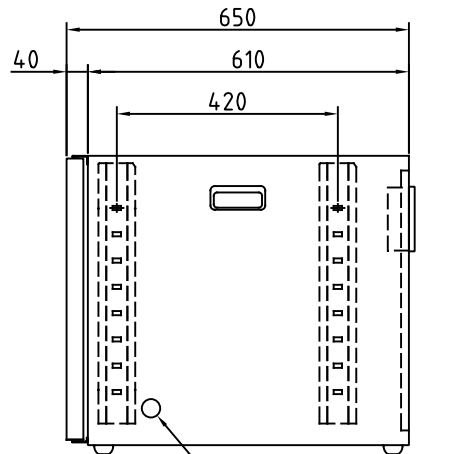

側面

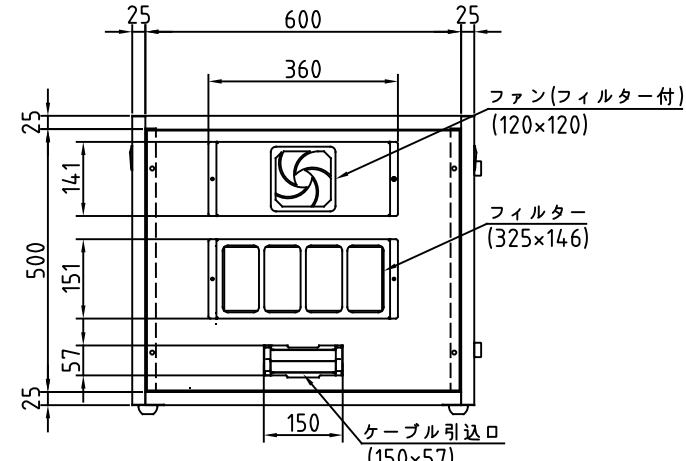

背面

材質 SPCC t1.0
 表面処理 7.5Y6/0.5μサ-トン
 数量 (/ 台)

Itemref	Quantity	Title/Name, designation, material, dimension etc			Article No./Reference	
Designed by n_tanba	Checked by	Approved by - date	Filename	Date 10/12/08	Scale 1:10	
エス・ディ・エス株式会社			L48F656 外觀図 (G仕様共通)			
			L48F656	Edition	Sheet 1/1	