

1

2

3

4

5

6

7

8

| RevNo | Revision note | Date | Signature | Checked |
|-------|---------------|------|-----------|---------|
| | | | | |

A

B

C

D

E

F

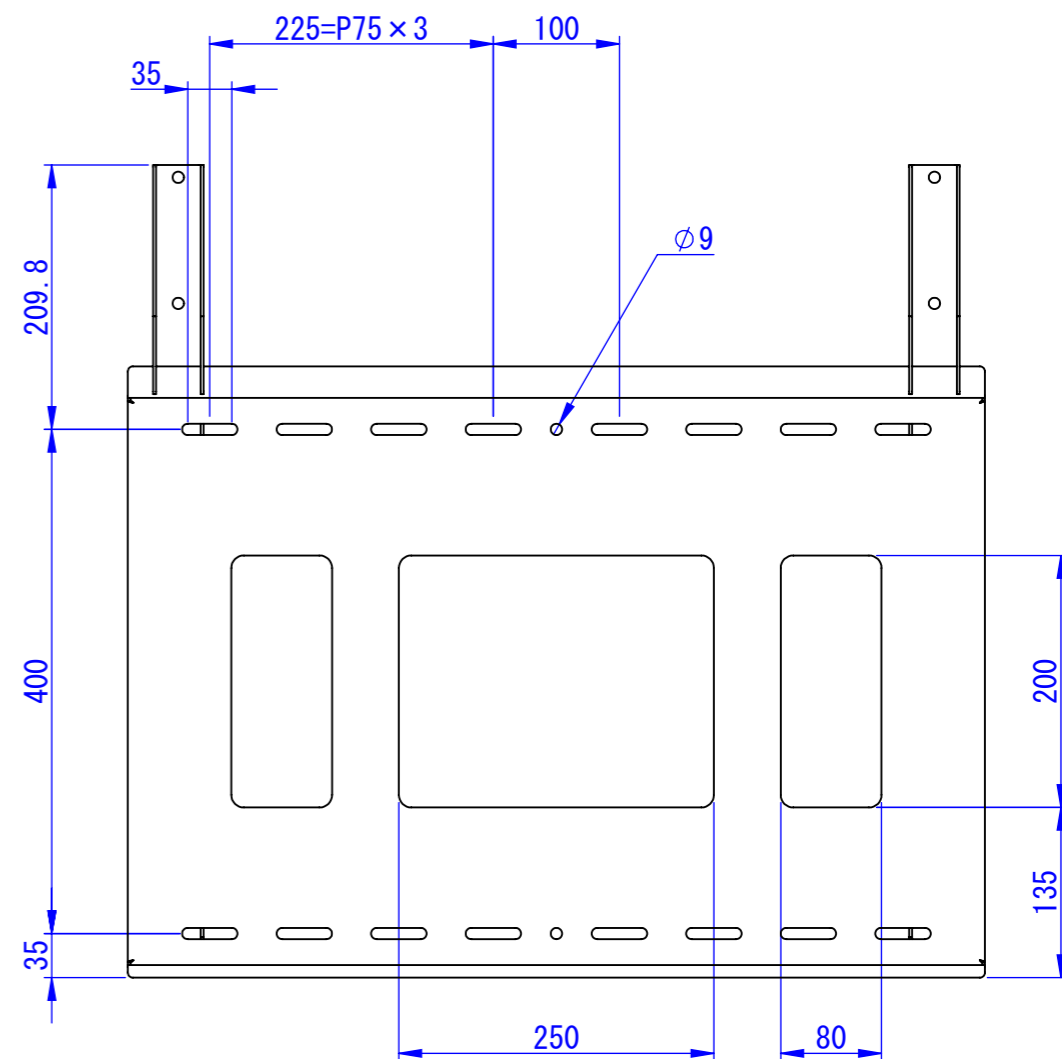
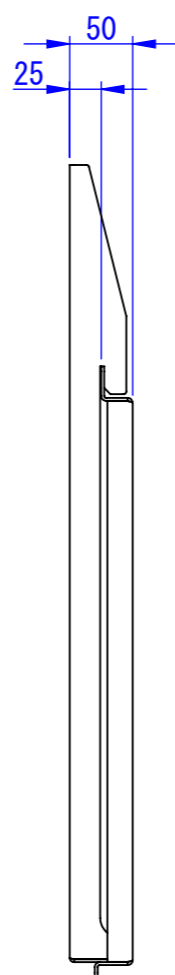
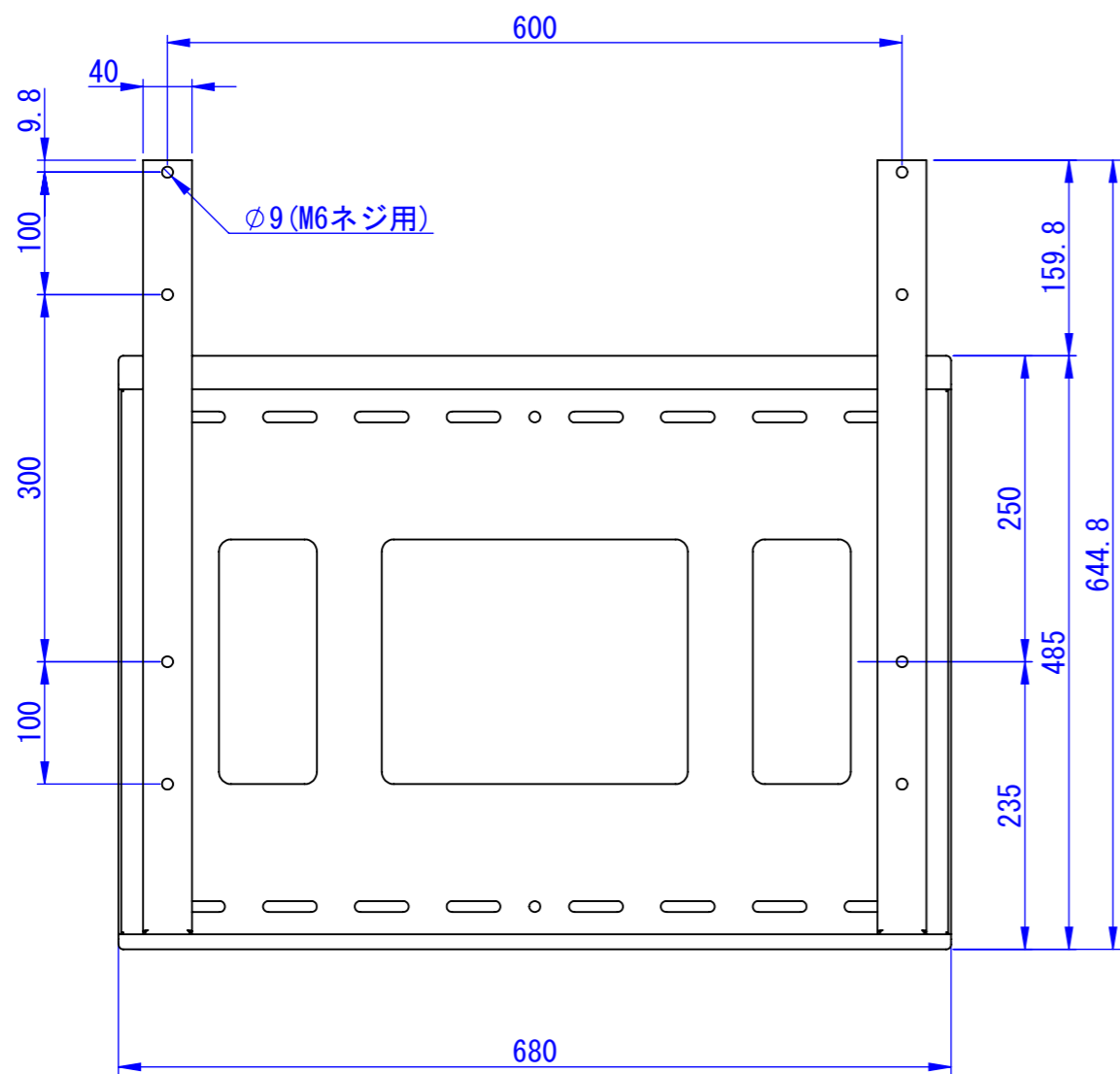
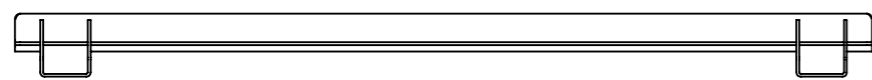

2021/09/13

表面処理 : N6.0リップル

| | | | | | |
|--------------------------|-----------------|-------------------------|--------------------------|------------------|--------------|
| Designed by D_Higashi | Checked by - | Approved by - date - | Filename SDDV148G1111 | Date 21/06/14 | Scale 1:6 |
| エス・ディ・エス株式会社 | | | Dケース専用壁掛け金具 | | |
| | | | FOP-WM10 | Edition - | Sheet 1/1 |

1

2

3

6

7

8

1

2

3

4

5

6

7

8

| | | | | |
|-------|---------------|------|-----------|---------|
| RevNo | Revision note | Date | Signature | Checked |
|-------|---------------|------|-----------|---------|

FF-DC10F-S

ディスプレイケース
中心高さ

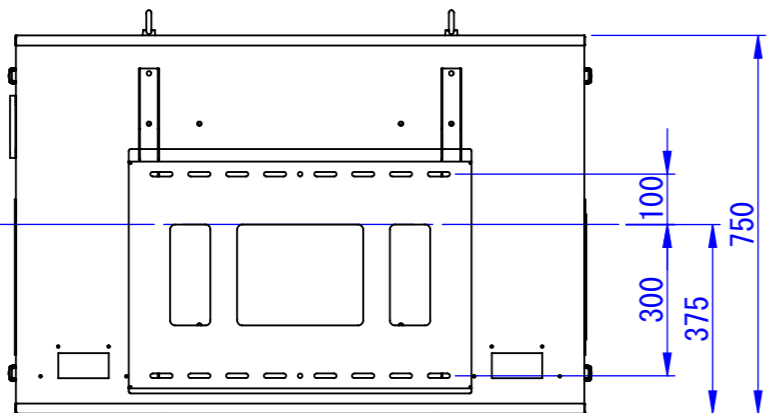

FF-DC10F-M

ディスプレイケース
中心高さ

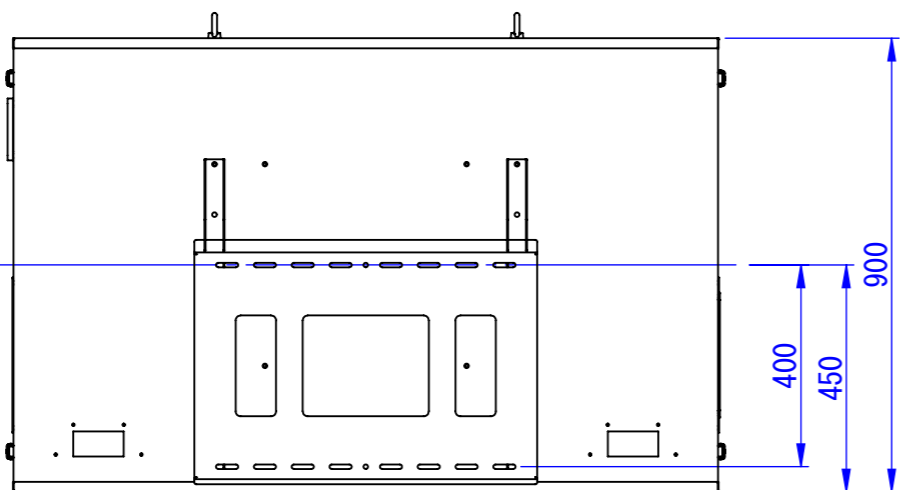

FF-DC10F-L

ディスプレイケース
中心高さ

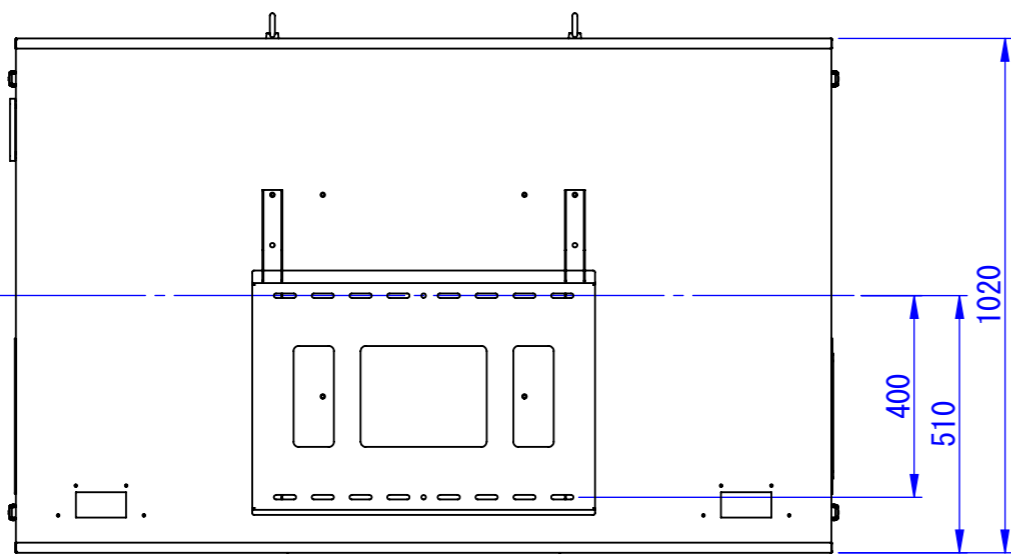

FF-DC10F-M、
FF-DC10F-L取付時に使用

FF-DC10F-S取付時に使用

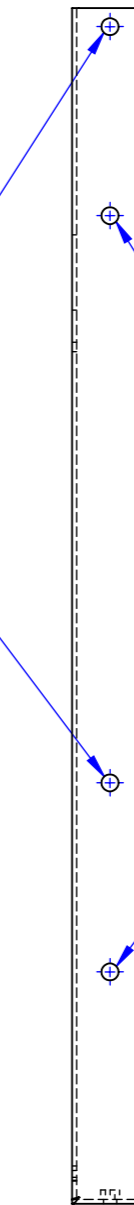

取付金具詳細

2021/09/13

| | | | | | |
|--------------------------|-----------------|-------------------------|--------------------------|------------------|---------------|
| Designed by D_Higashi | Checked by - | Approved by - date - | Filename SDDV148G1112 | Date 21/09/13 | Scale 1:15 |
| エス・ディ・エス株式会社 | | | Dケース専用壁掛け金具 | | |
| | | | FOP-WM10 | Edition - | Sheet 1/1 |

1

2

3

6

7

8