

REV.	DESCRIPTION	DATE	APPL.
A	新規作成	21/10/27	

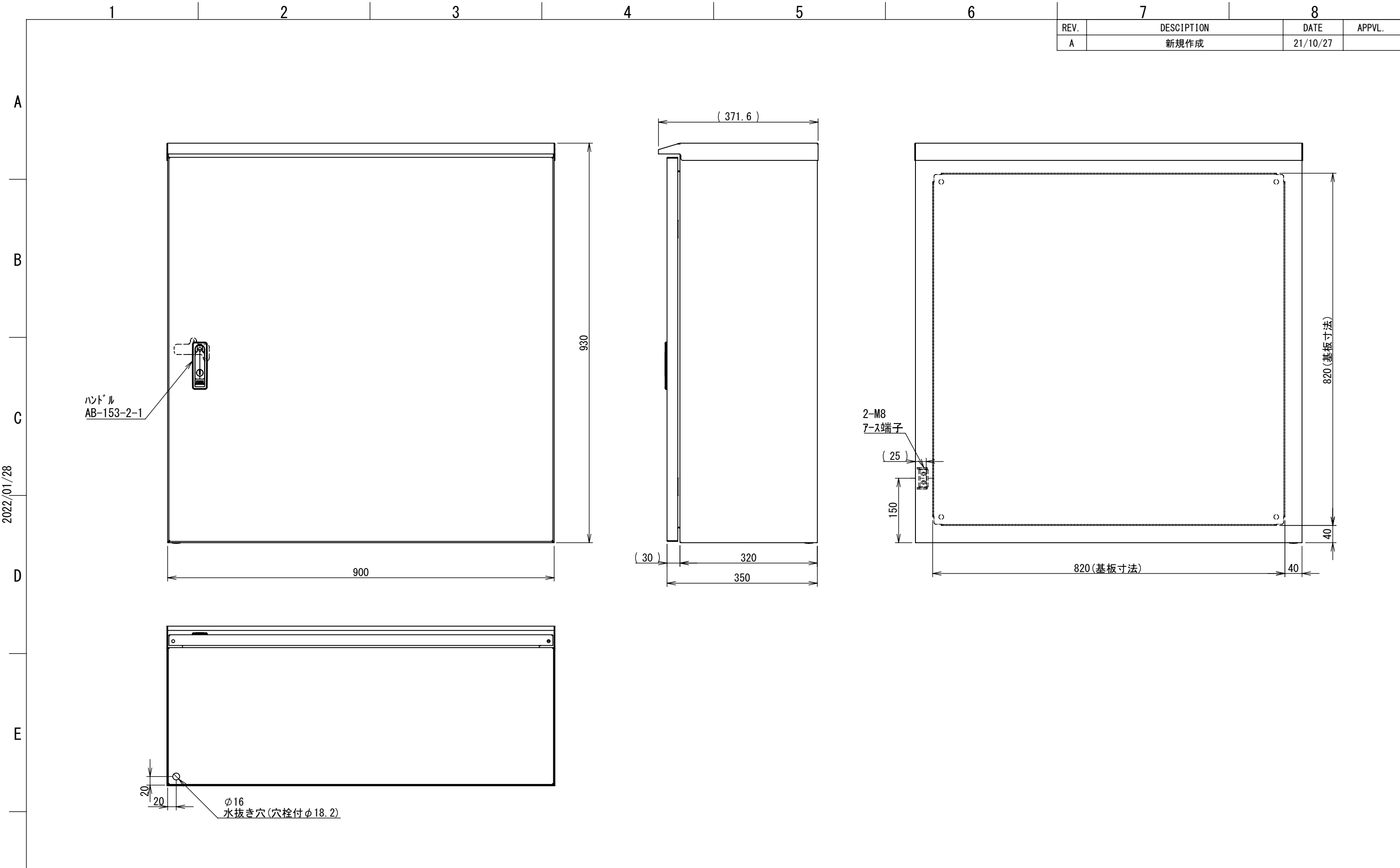

2022/01/28

Note :  
 材質 別途記載  
 塗装 5Y7/1. 半ツヤ(標準色)

Designed by Yokogawa	Checked by -	Approved by - date -	Filename FWR000A00	Date 21/10/27	Scale 1:8
エス・ディ・エス株式会社			制御BOX/FWR35-99S		
			FWR000A00	Edition A	Sheet 1/2

2022/01/28

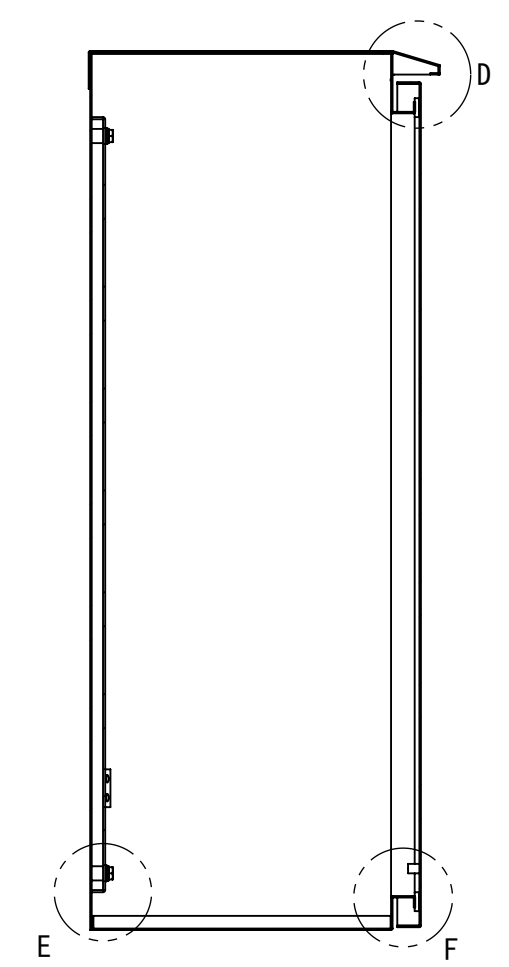
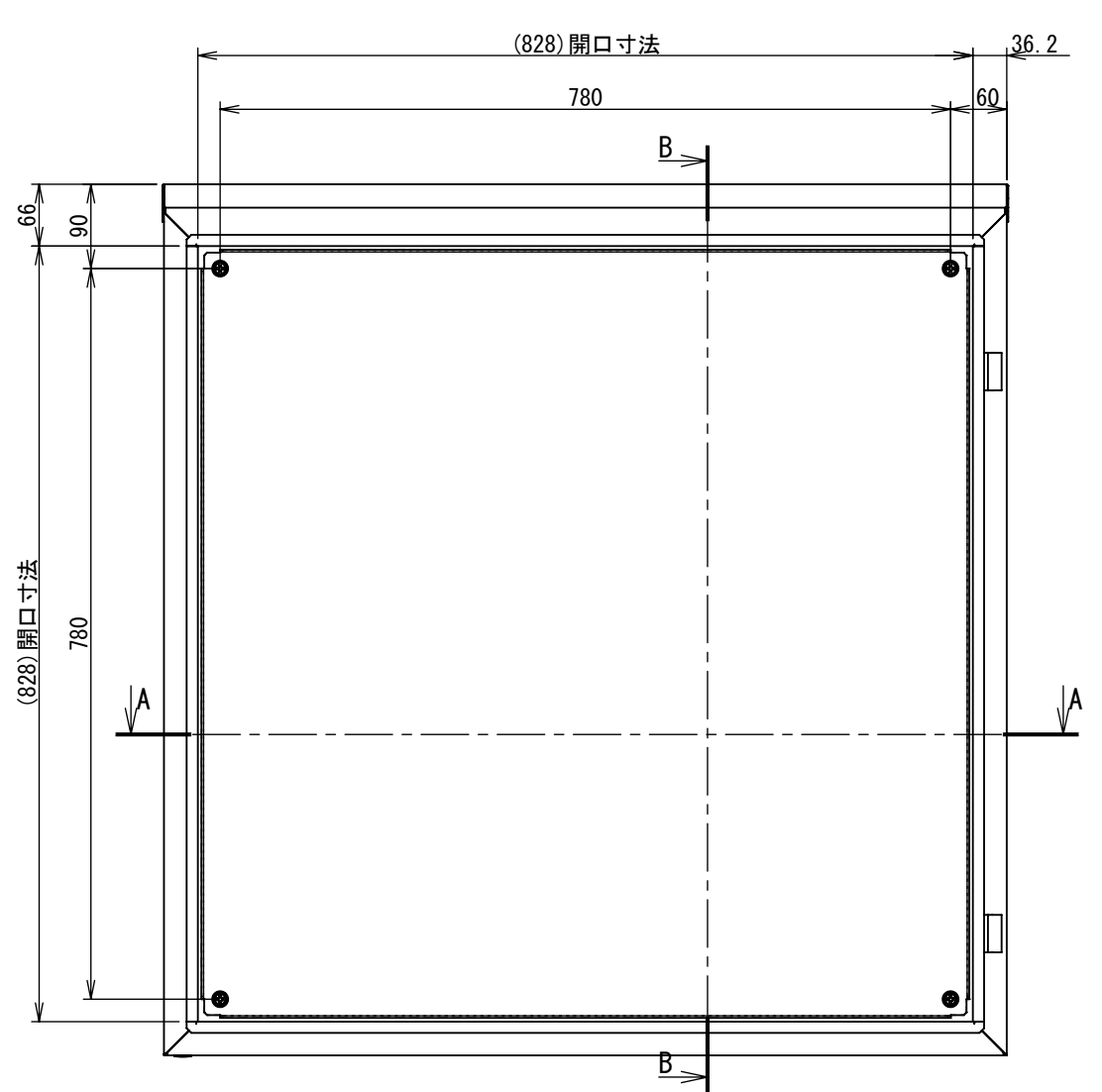

断面図 B-B

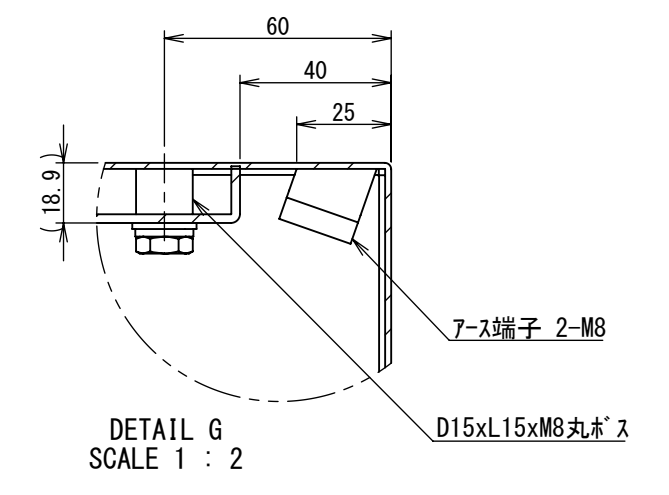

DETAIL G  
SCALE 1 : 2

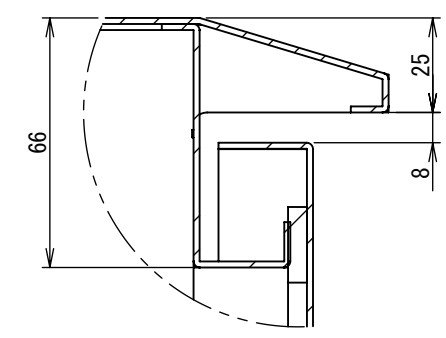

DETAIL D  
SCALE 1 : 2

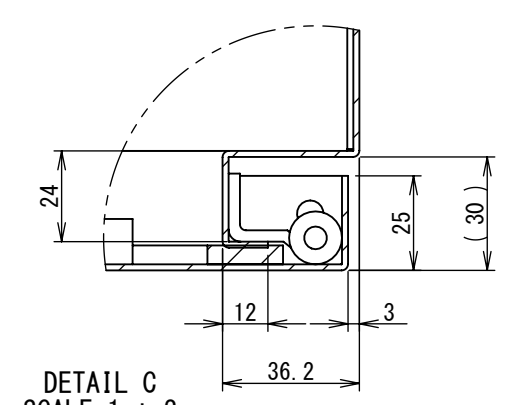

DETAIL C  
SCALE 1 : 2

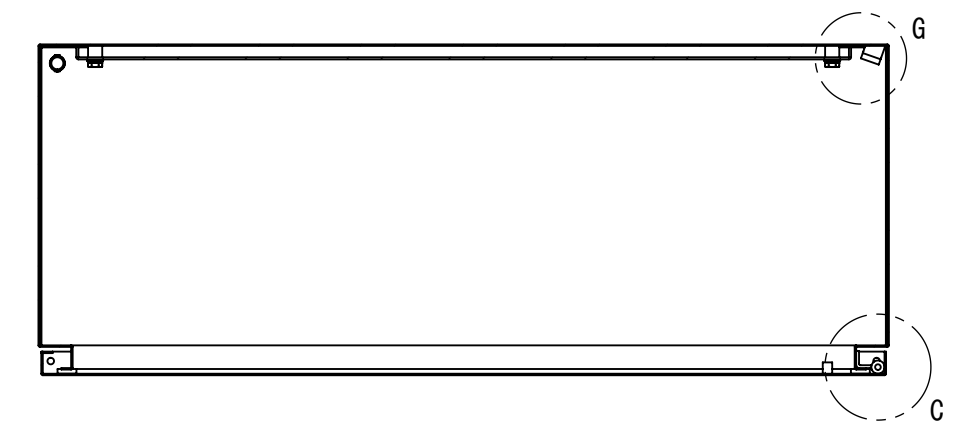

断面図 A-A

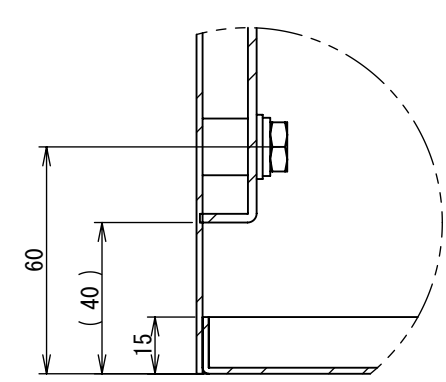

DETAIL E  
SCALE 1 : 2

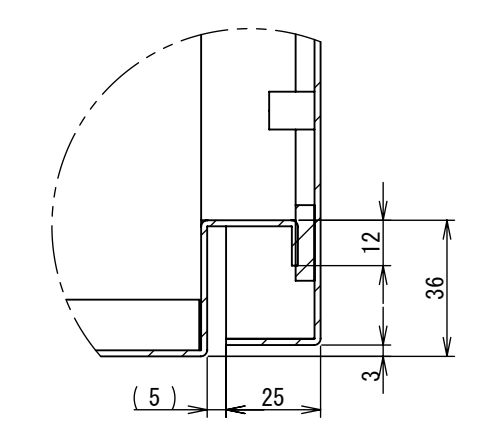

DETAIL F  
SCALE 1 : 2

Note :  
材質 別途記載  
塗装 5Y7/1. 半ツヤ(標準色)

Designed by Yokogawa	Checked by -	Approved by - date -	Filename FWR000A00	Date 21/10/27	Scale 1:8
エス・ディ・エス株式会社			制御BOX/FWR35-99S		
			FWR000A00	Edition A	Sheet 2/2