

REV.	DESCRIPTION	DATE	APPVL.
A	新規作成	21/10/27	

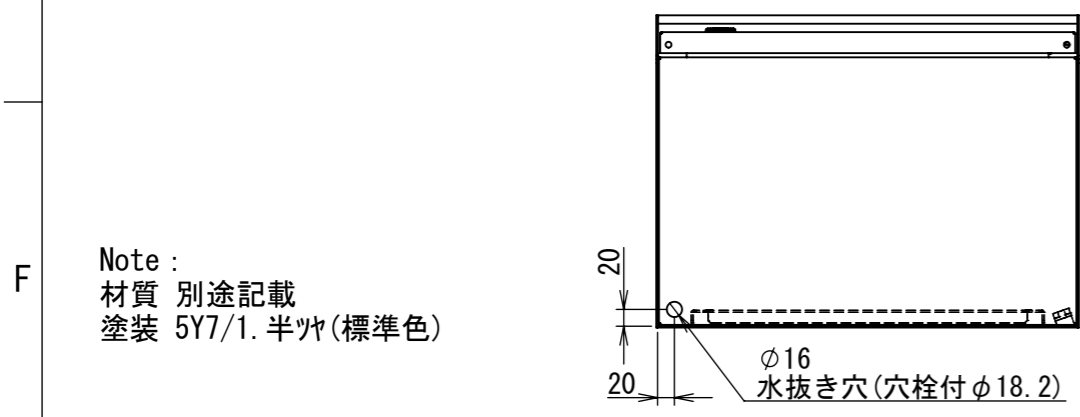
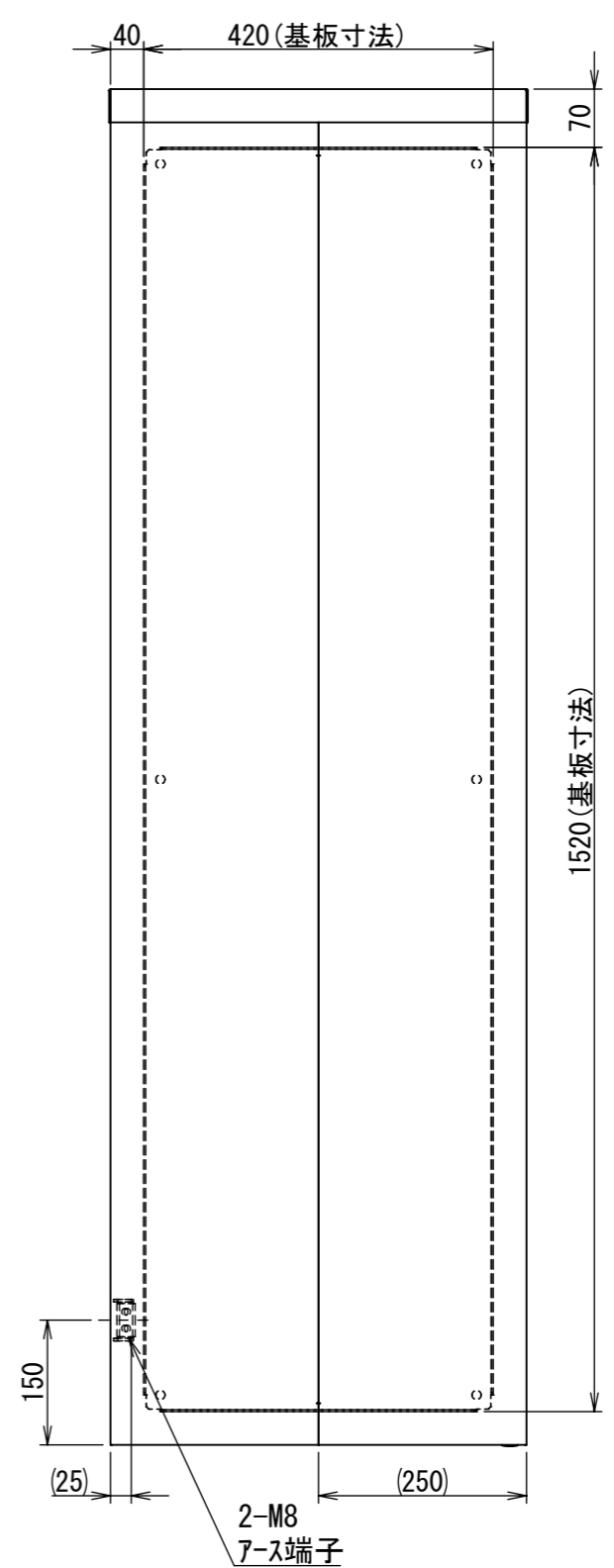
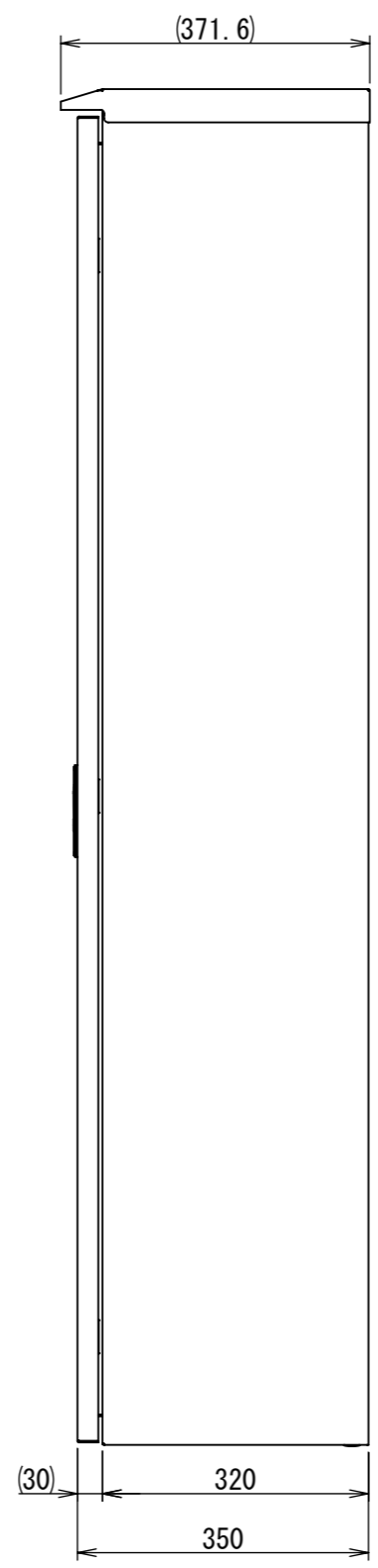
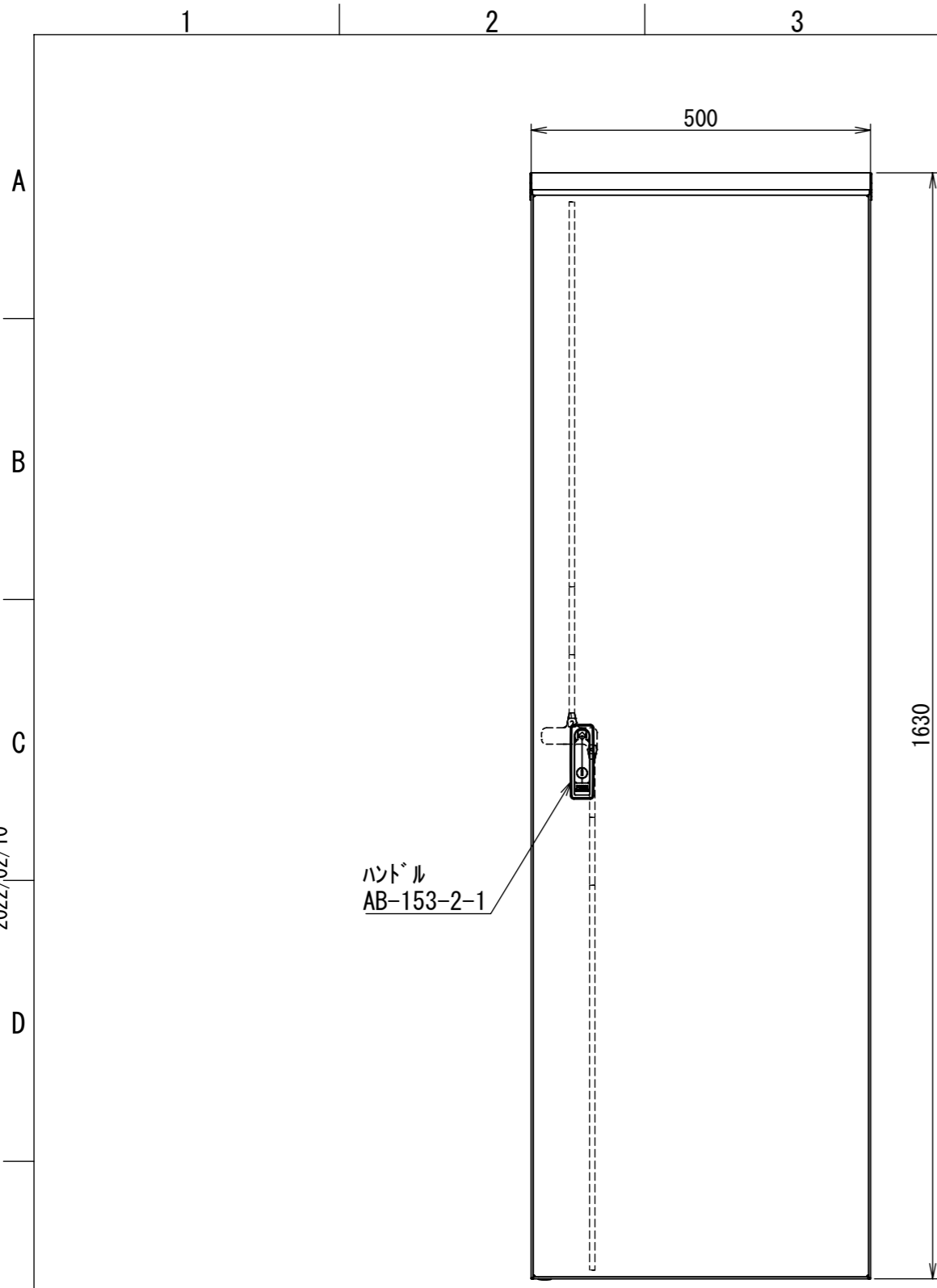

Note :
材質 別途記載
塗装 5Y7/1. 半ツヤ (標準色)

Designed by Yokogawa	Checked by -	Approved by - date -	Filename FWR0000A00	Date 21/10/27	Scale 1:9
エス・ディ・エス株式会社			制御BOX/FWR35-516S		
			FWR0000A00	Edition A	Sheet 1/2

2022/02/10

A
B
C
D
E
F

A
B
C
D
E
F

1 2 3 4 5 6 7 8

1 2 3 4 5 6 7 8

2022/02/10

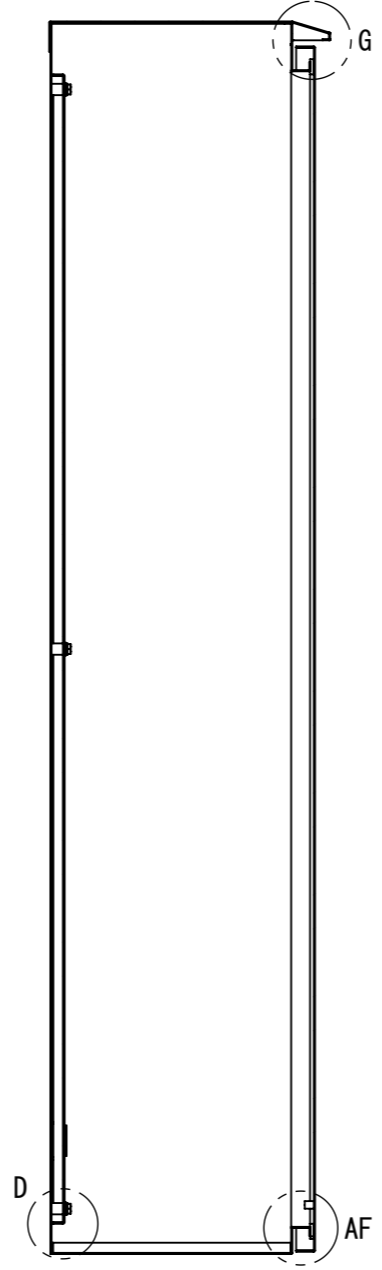
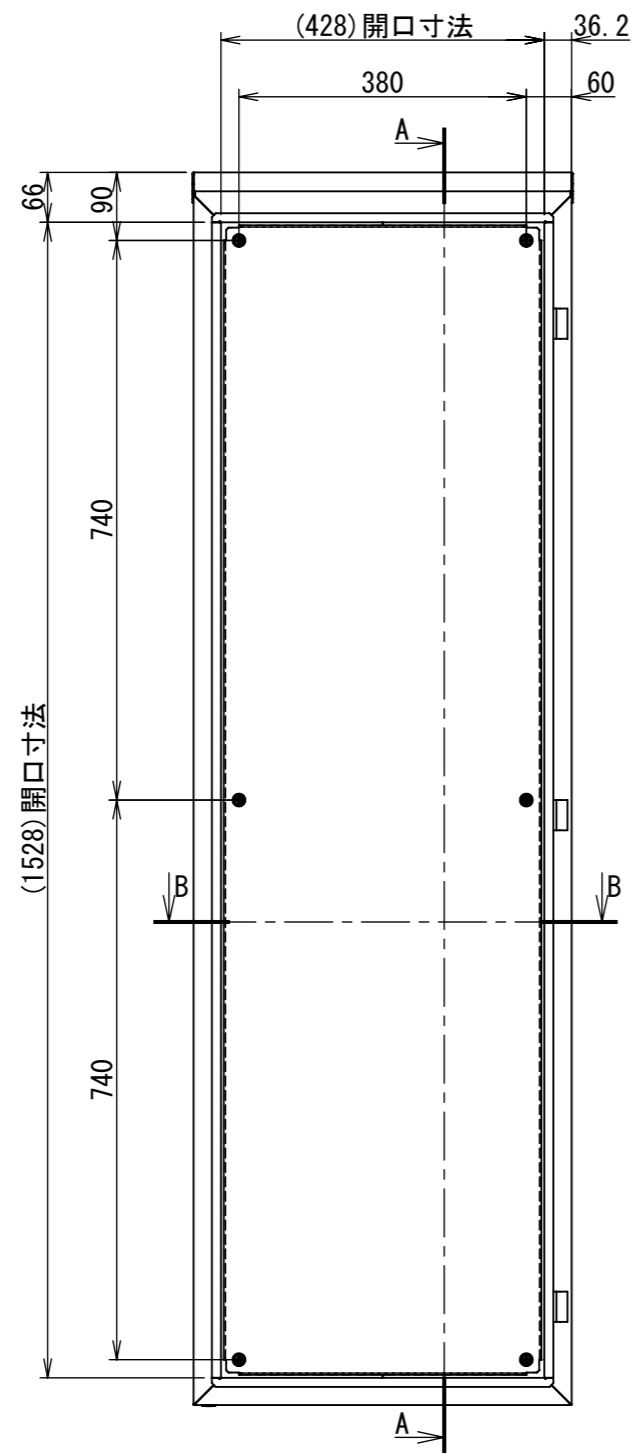

断面図 A-A

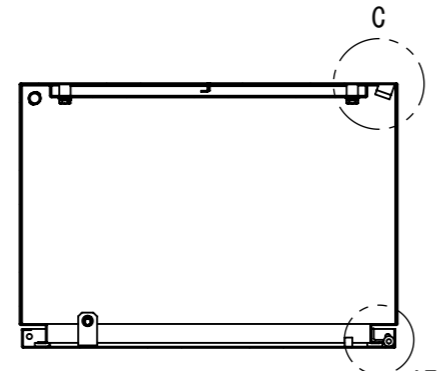
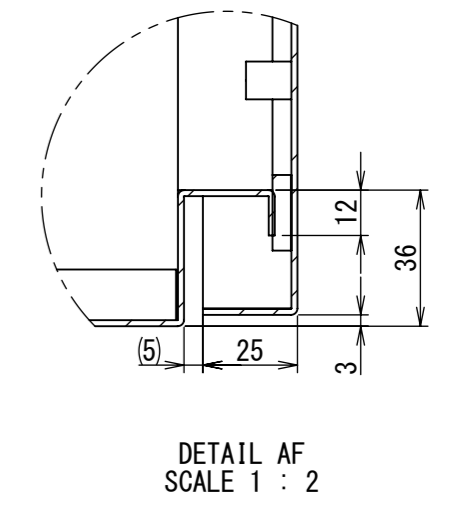
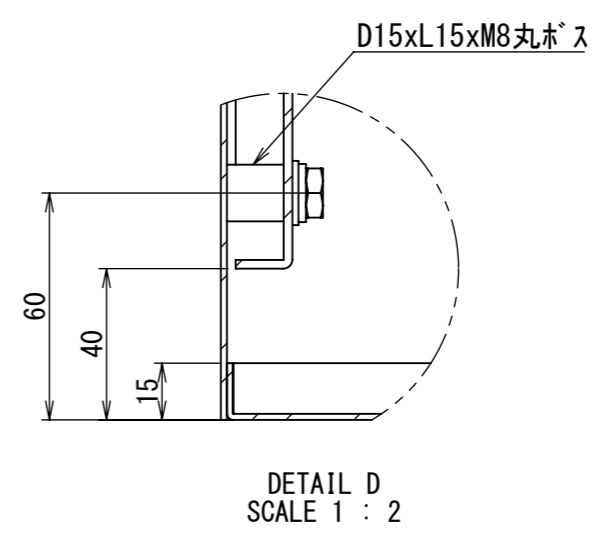
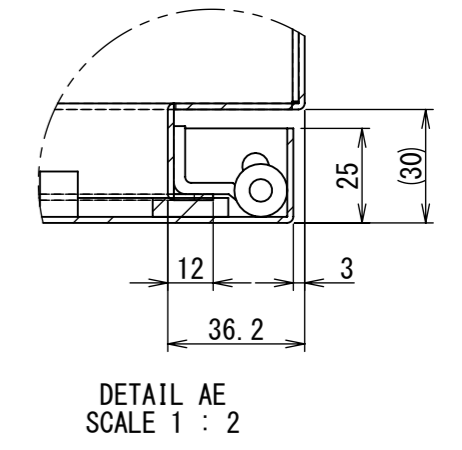
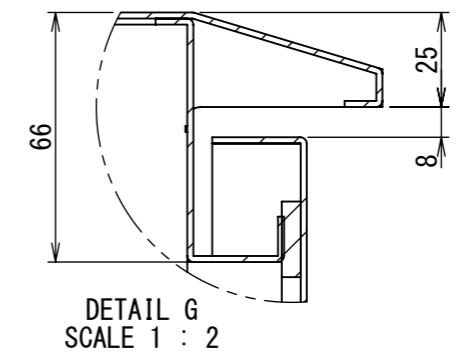
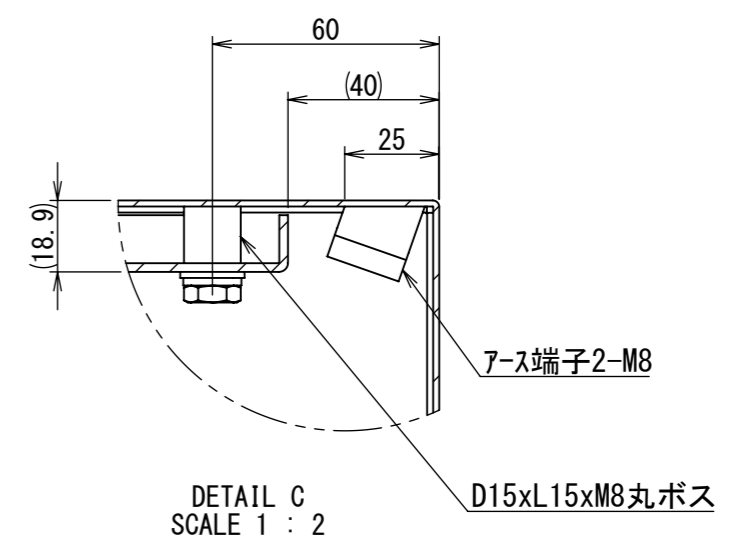

断面図 B-B

Note :
材質 別途記載
塗装 5Y7/1. 半ツヤ(標準色)

Designed by Yokogawa	Checked by -	Approved by - date -	Filename FWR0000A00	Date 21/10/27	Scale 1:10
エス・ディ・エス株式会社			制御BOX/FWR35-516S		
			FWR0000A00	Edition A	Sheet 2/2