

REV.	DESCRIPTION	DATE	APPL.
A	新規作成	21/10/27	

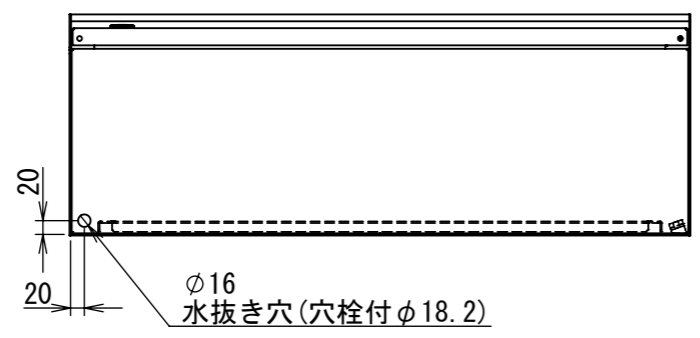
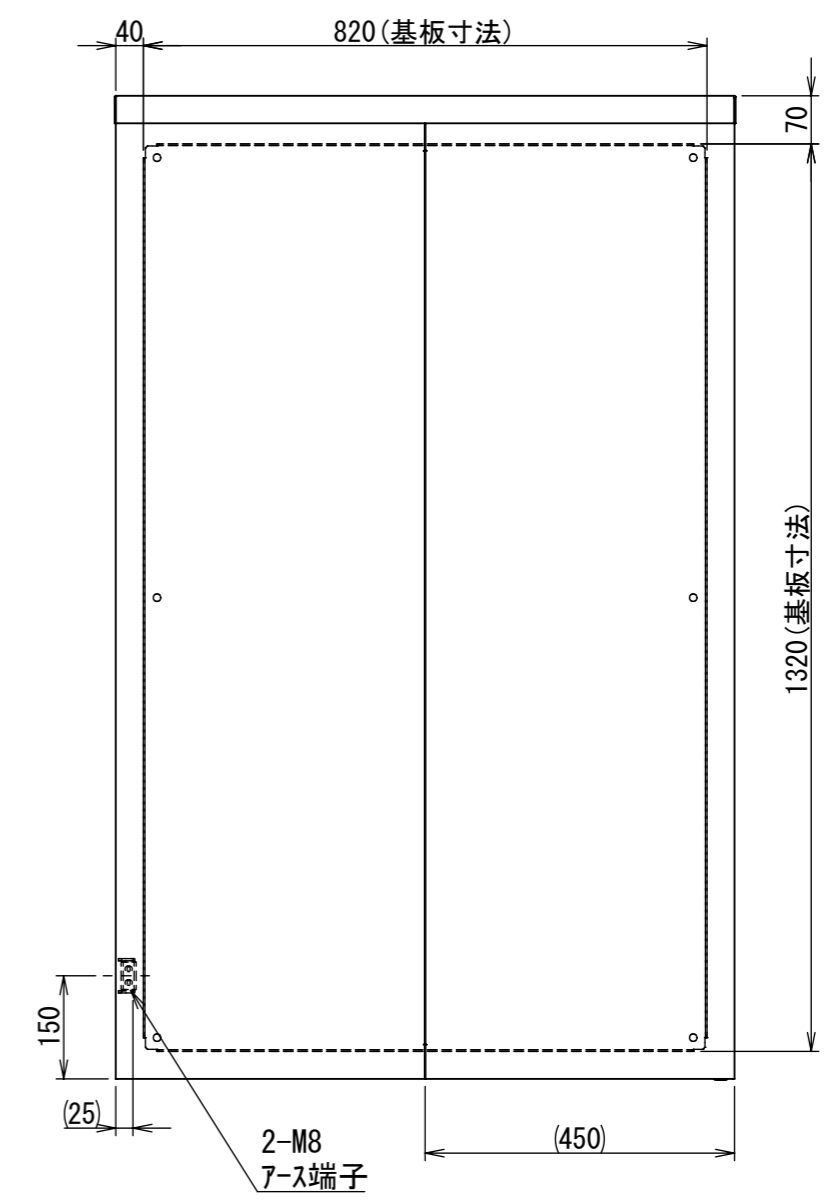
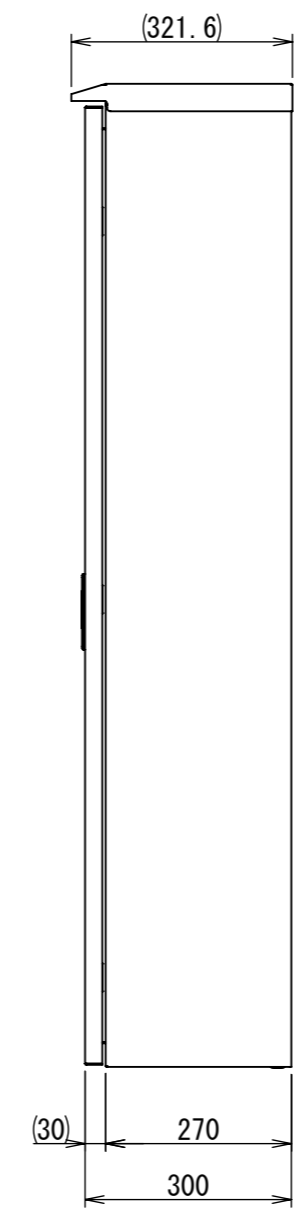
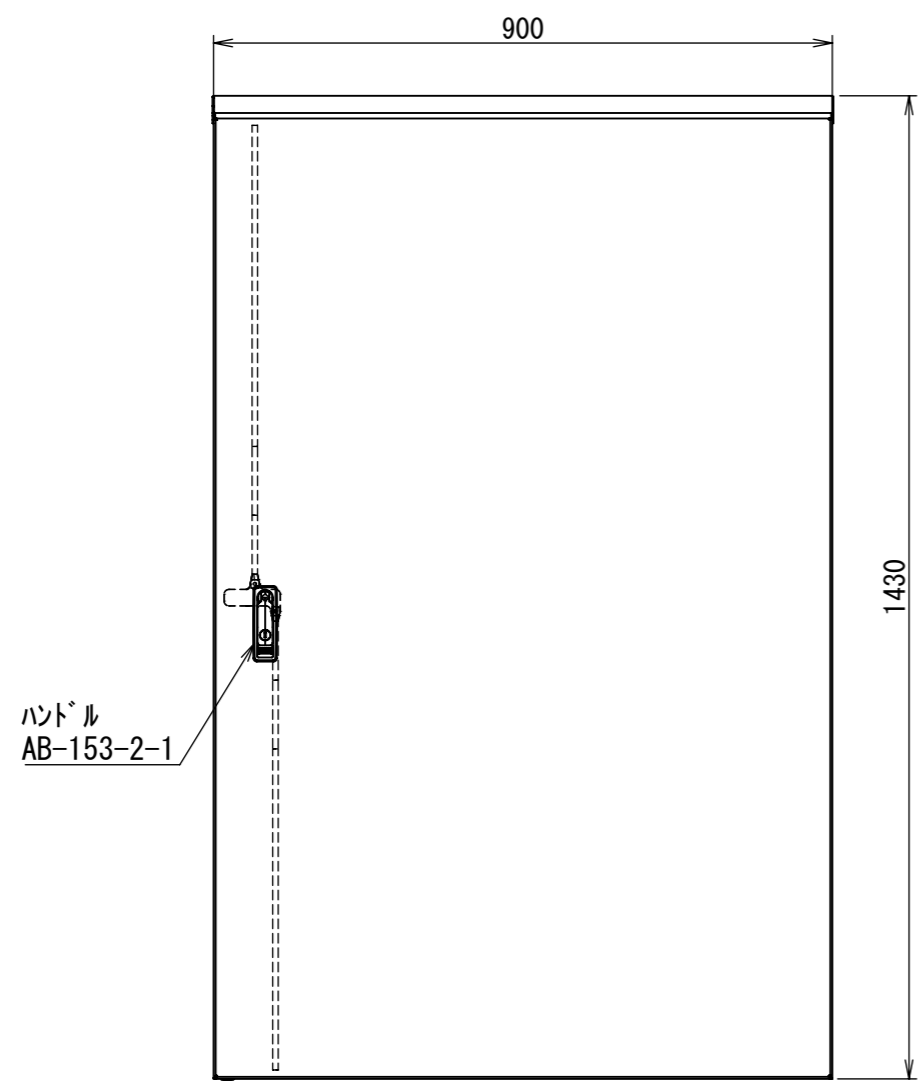

Note :
材質 別途記載
塗装 5Y7/1. 半ツヤ(標準色)

Designed by Yokogawa	Checked by -	Approved by - date -	Filename FWR0000A00	Date 21/10/27	Scale 1:11
エス・ディ・エス株式会社			制御BOX/FWR30-914S		
			FWR0000A00	Edition A	Sheet 1/2

2022/01/28

A
B
C
D
E
F

A
B
C
D
E
F

1

2

3

4

5

6

7

8

1

2

3

6

7

8

2022/01/28

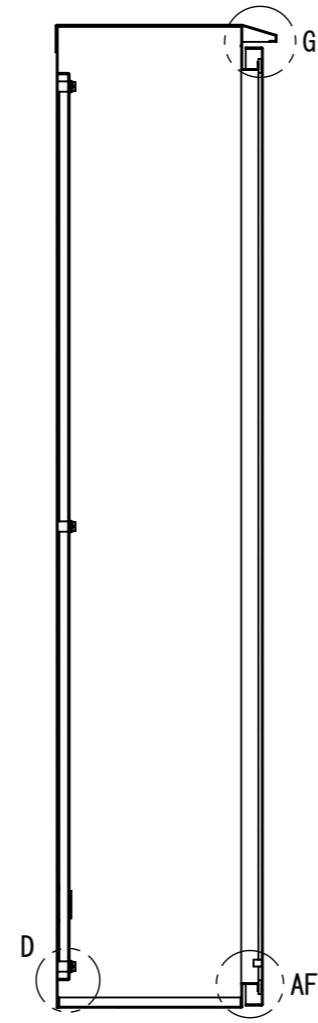
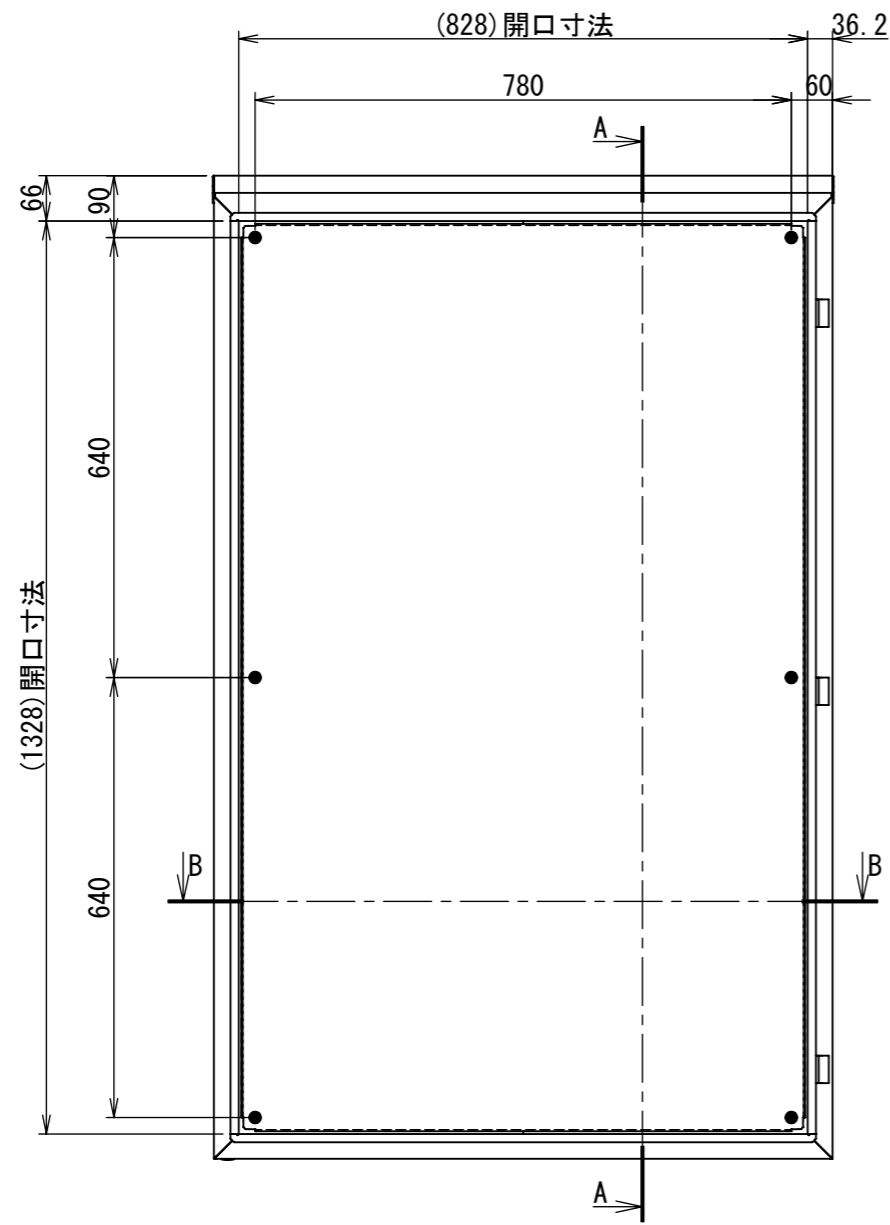

断面図 A-A

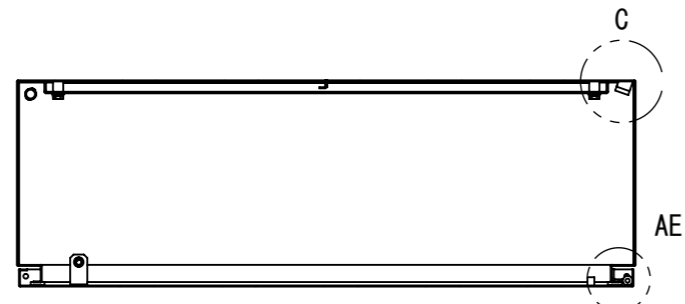

断面図 B-B

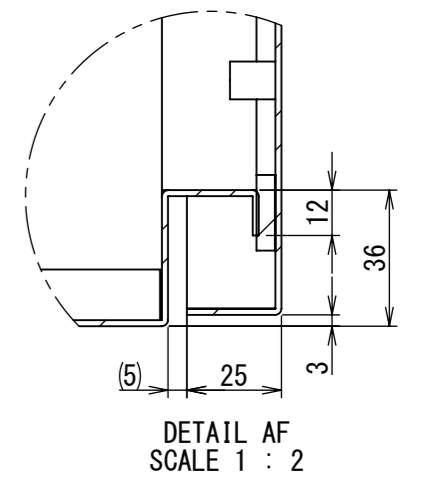
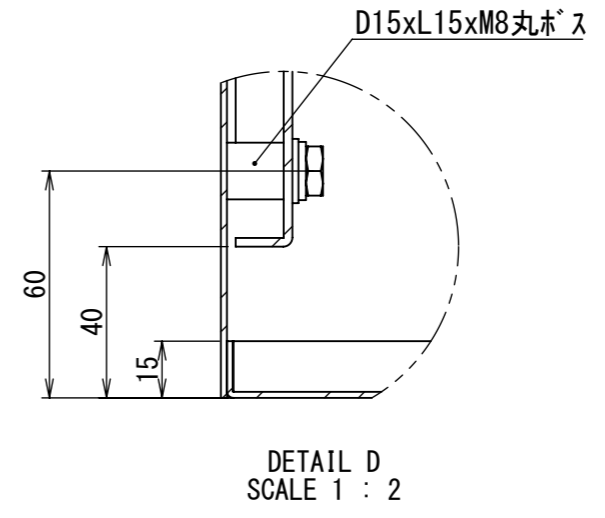
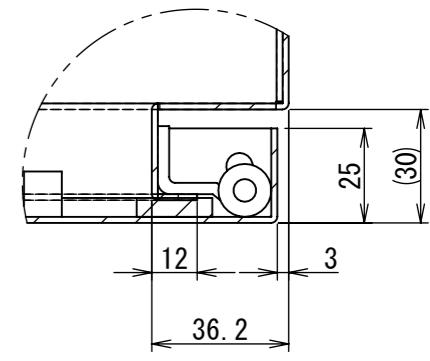
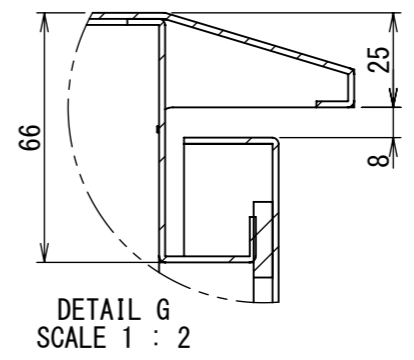
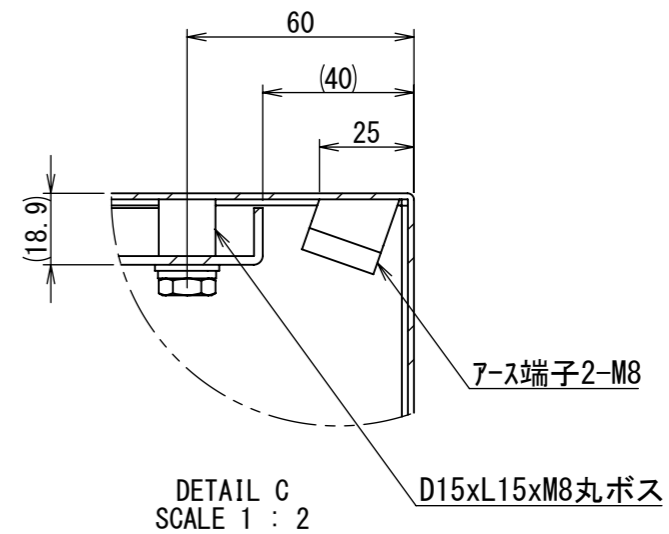

Note :
 材質 別途記載
 塗装 5Y7/1. 半ツヤ(標準色)

Designed by Yokogawa	Checked by -	Approved by - date -	Filename FWR0000A00	Date 21/10/27	Scale 1:11
エス・ディ・エス株式会社			制御BOX/FWR30-914S		
			FWR0000A00	Edition A	Sheet 2/2