

REV.	DESCRIPTION	DATE	APPL.
A	新規作成	21/10/27	

2022/02/10

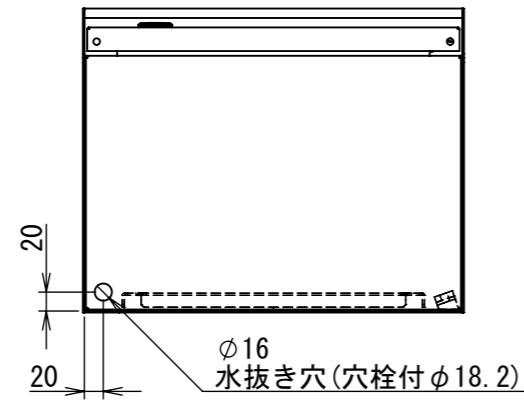
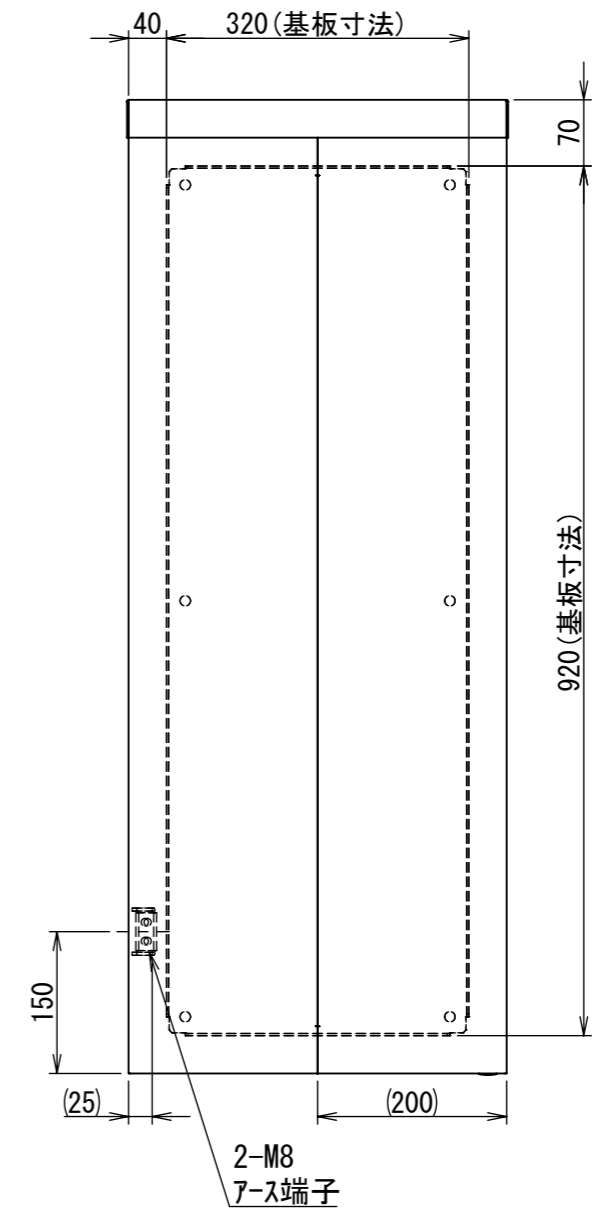
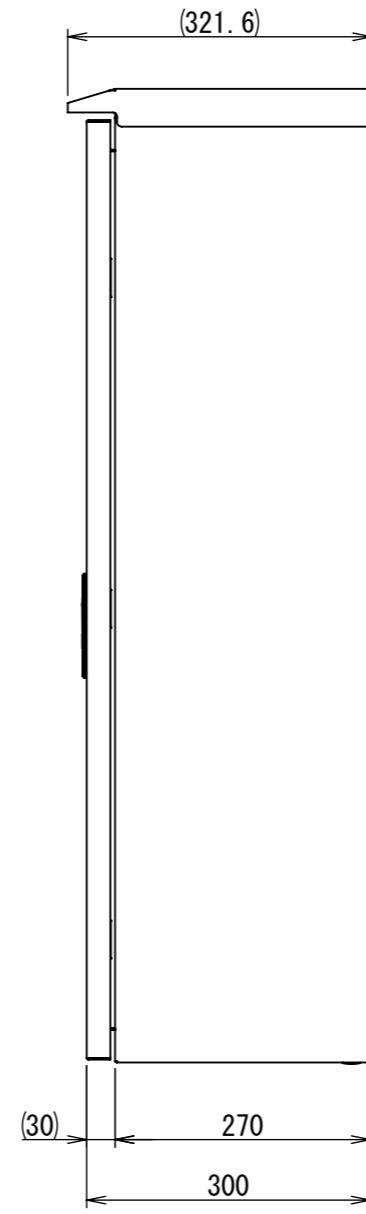
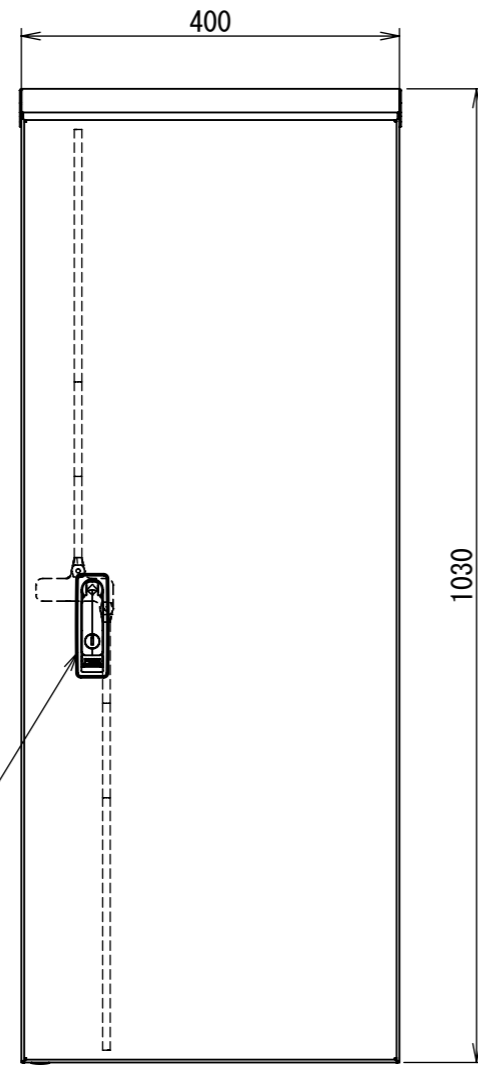

Note :
 材質 別途記載
 塗装 5Y7/1. 半ツヤ(標準色)

Designed by Yokogawa	Checked by -	Approved by - date -	Filename FWR0000A00	Date 21/10/27	Scale 1:8
エス・ディ・エス株式会社			制御BOX/FWR30-410S		
			FWR0000A00	Edition A	Sheet 1/2

2022/02/10

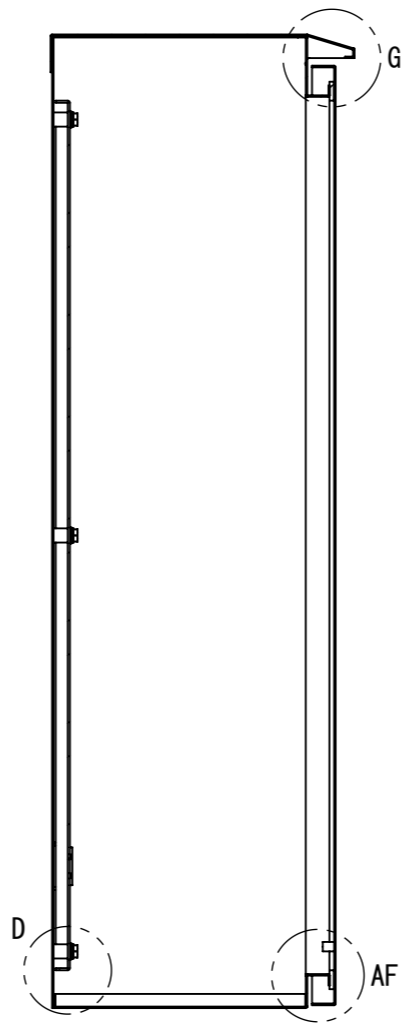
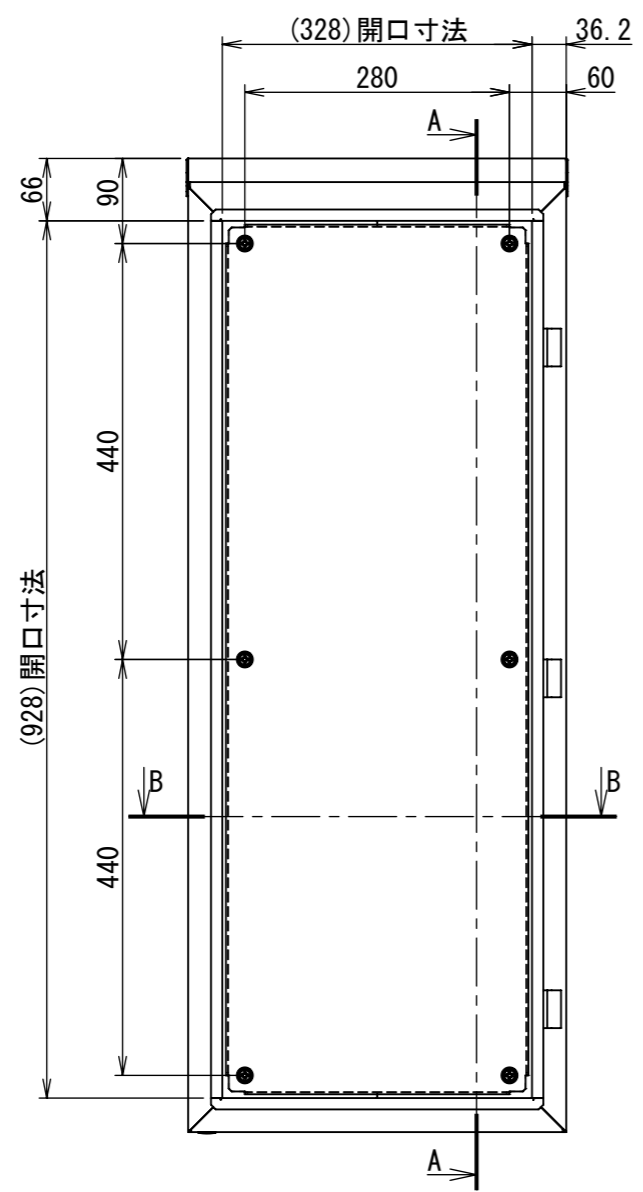

断面図 A-A

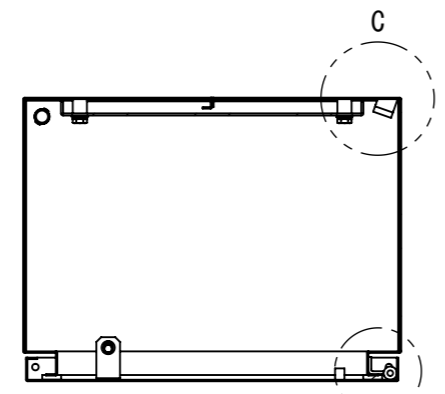

断面図 B-B

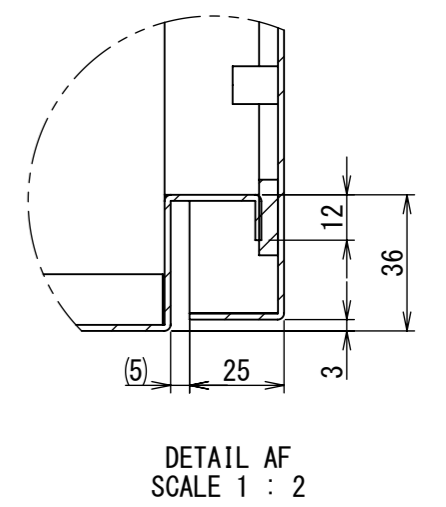
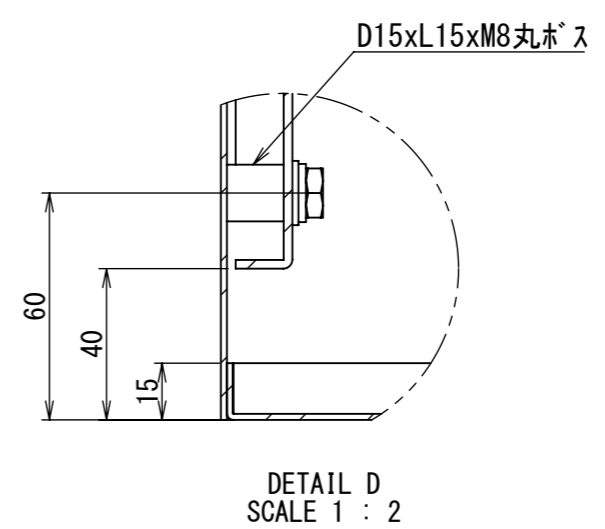
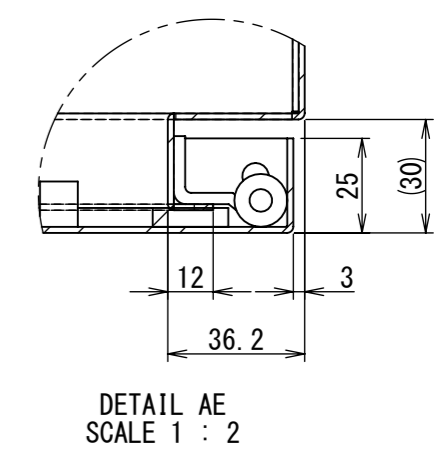
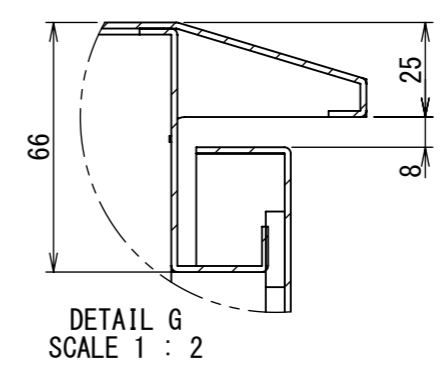
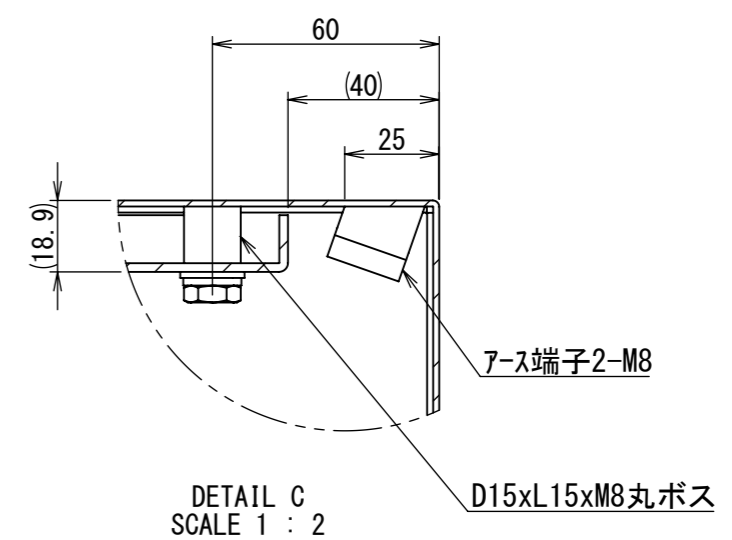

Note :
材質 別途記載
塗装 5Y7/1. 半ツヤ(標準色)

Designed by Yokogawa	Checked by -	Approved by - date -	Filename FWR0000A00	Date 21/10/27	Scale 1:8
エス・ディ・エス株式会社			制御BOX/FWR30-410S		
			FWR0000A00	Edition A	Sheet 2/2