

REV.	DESCRIPTION	DATE	APPL.
A	新規作成	21/10/27	

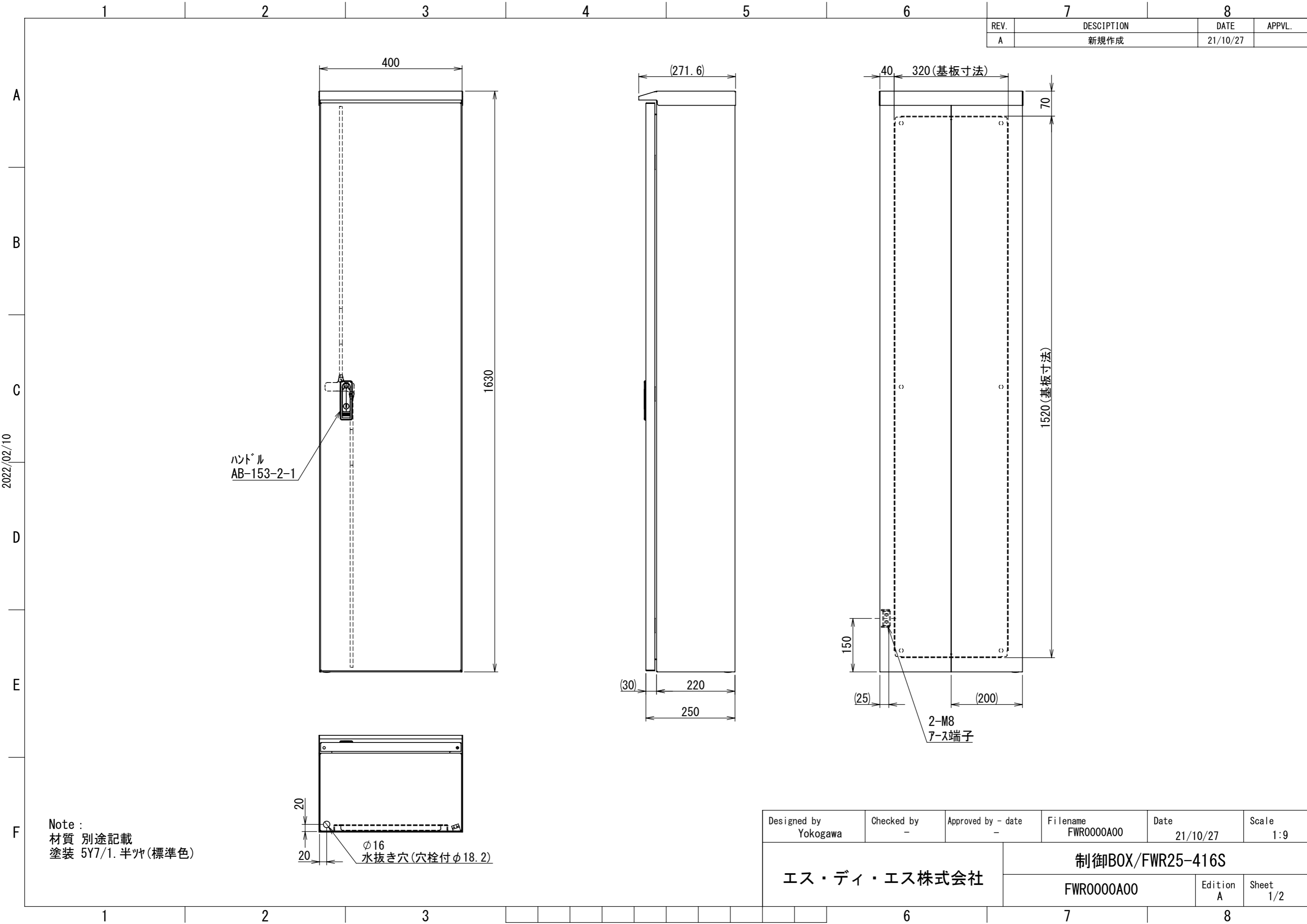

2022/02/10

Note :
 材質 別途記載
 塗装 5Y7/1. 半ツヤ(標準色)

Designed by Yokogawa	Checked by -	Approved by - date -	Filename FWR0000A00	Date 21/10/27	Scale 1:9
エス・ディ・エス株式会社			制御BOX/FWR25-416S		
			FWR0000A00	Edition A	Sheet 1/2

2022/02/10

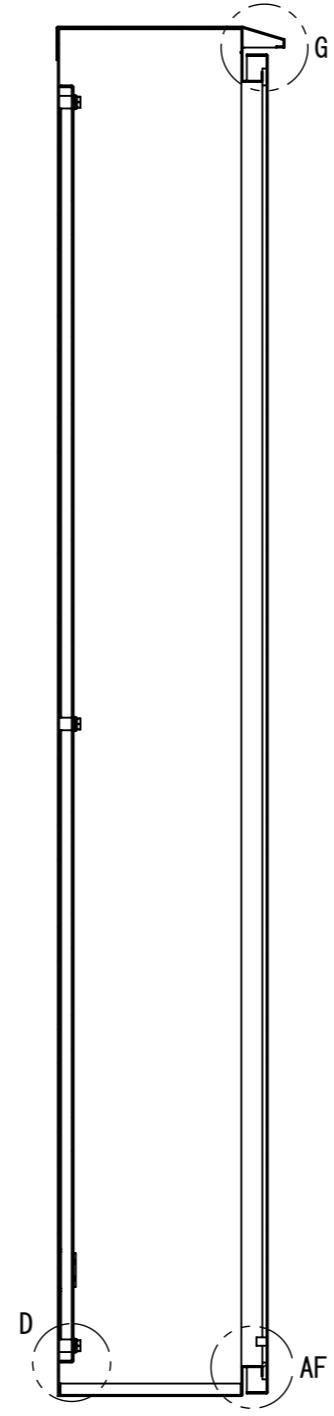
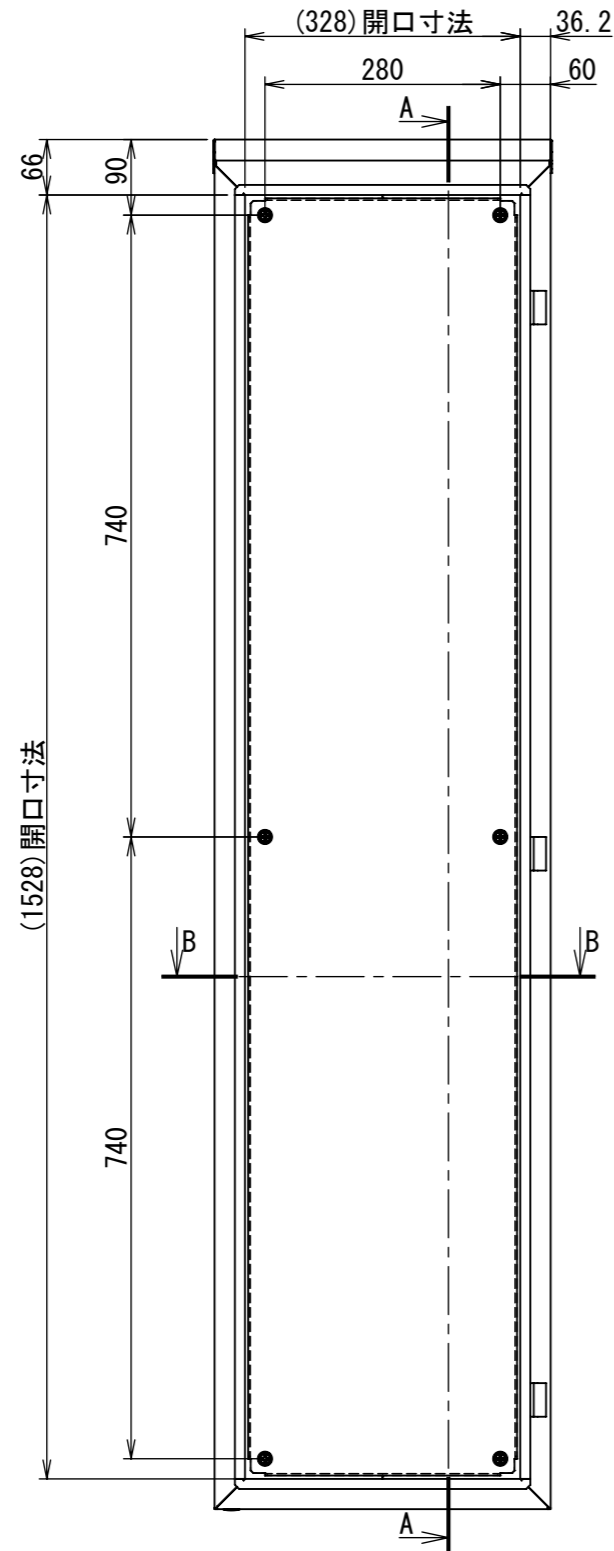

断面図 A-A

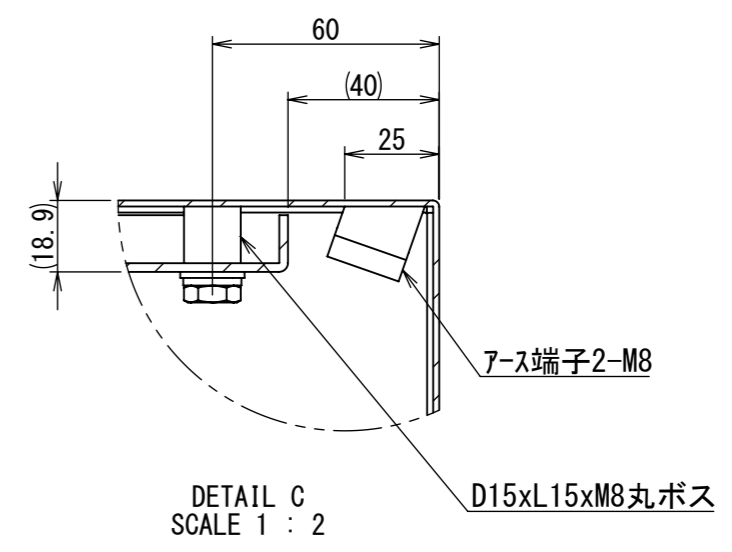

DETAIL C
SCALE 1 : 2

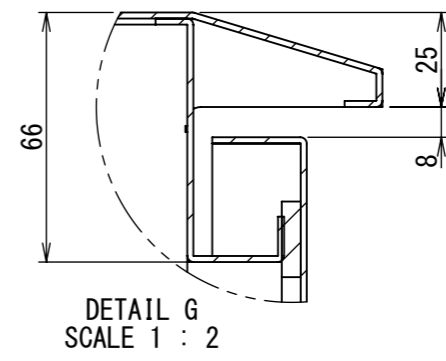

DETAIL G
SCALE 1 : 2

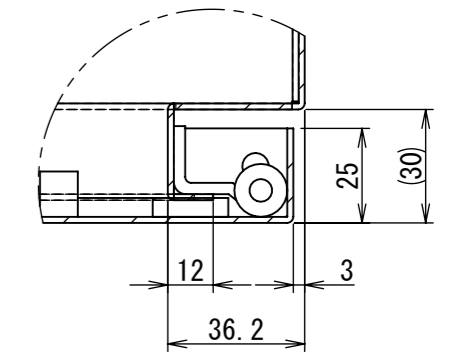

DETAIL AE
SCALE 1 : 2

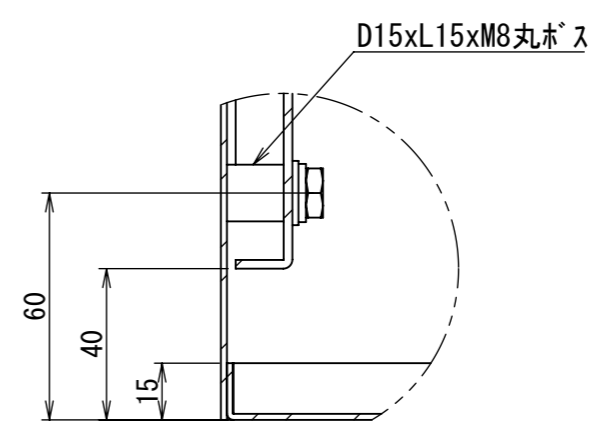

DETAIL D
SCALE 1 : 2

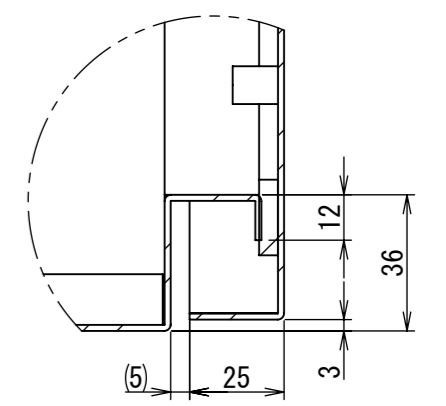

DETAIL AF
SCALE 1 : 2

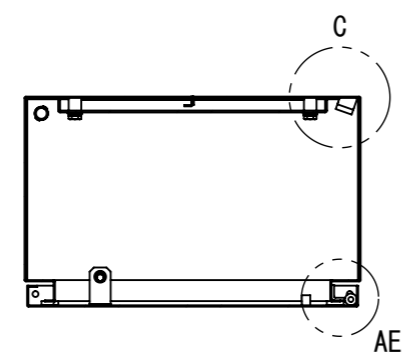

断面図 B-B

Note :
 材質 別途記載
 塗装 5Y7/1. 半ツヤ(標準色)

Designed by Yokogawa	Checked by -	Approved by - date -	Filename FWR0000A00	Date 21/10/27	Scale 1:9
エス・ディ・エス株式会社			制御BOX/FWR25-416S		
			FWR0000A00	Edition A	Sheet 2/2