

REV.	DESCRIPTION	DATE	APPVL.
A	新規作成	21/10/27	

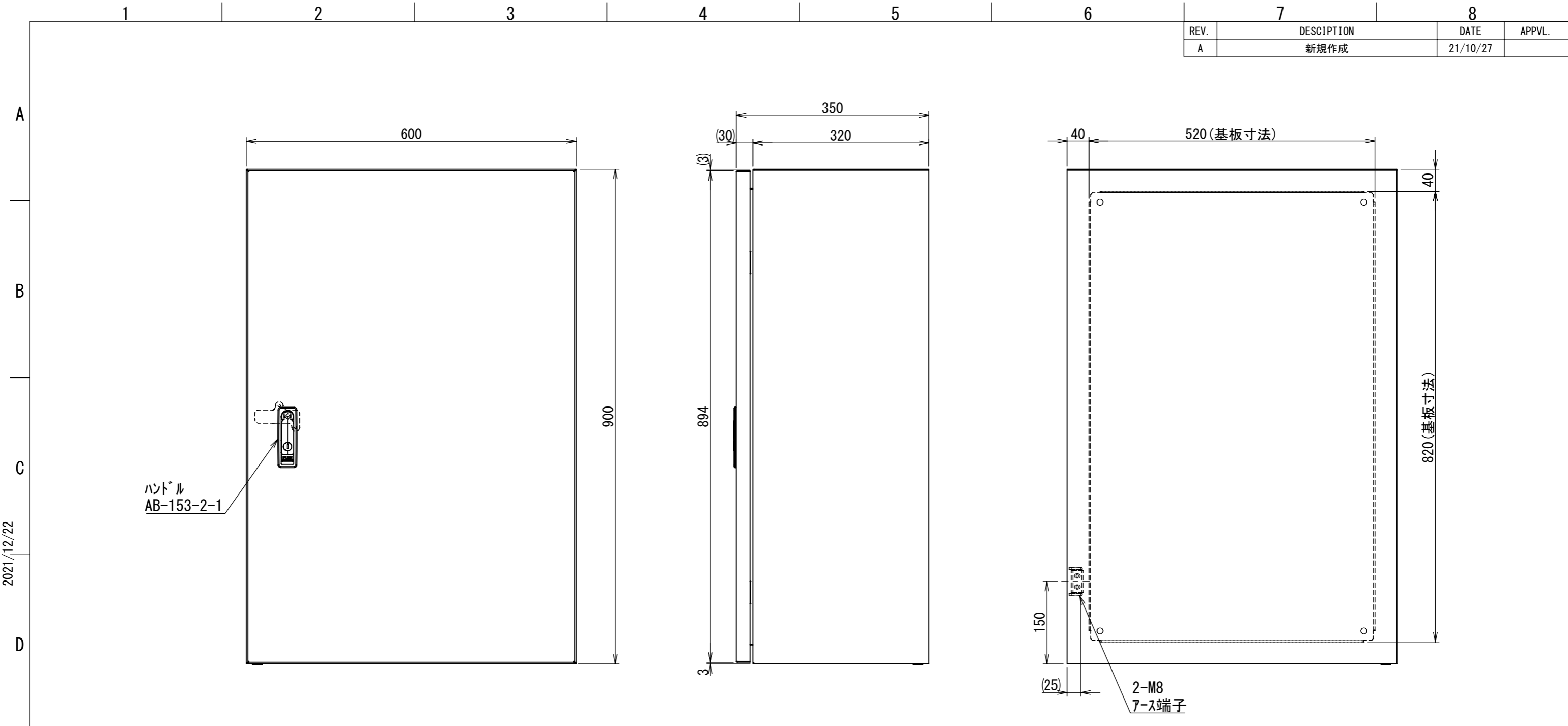

2021/12/22

ハンドル
AB-153-2-1

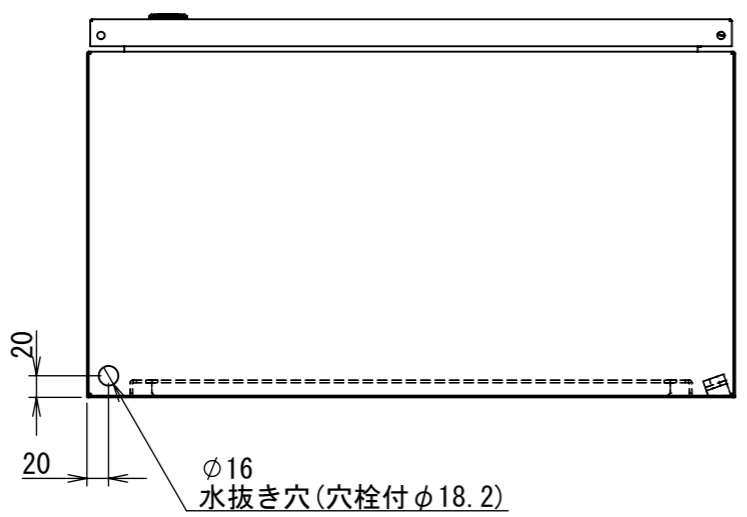

Note :
材質 別途記載
塗装 5Y7/1 半ツヤ(標準色)

Designed by Yokogawa	Checked by -	Approved by - date -	Filename FWS000A00	Date 21/10/27	Scale 1:7
エス・ディ・エス株式会社			制御BOX/FW35-69S		
			FWS000A00	Edition A	Sheet 1/2

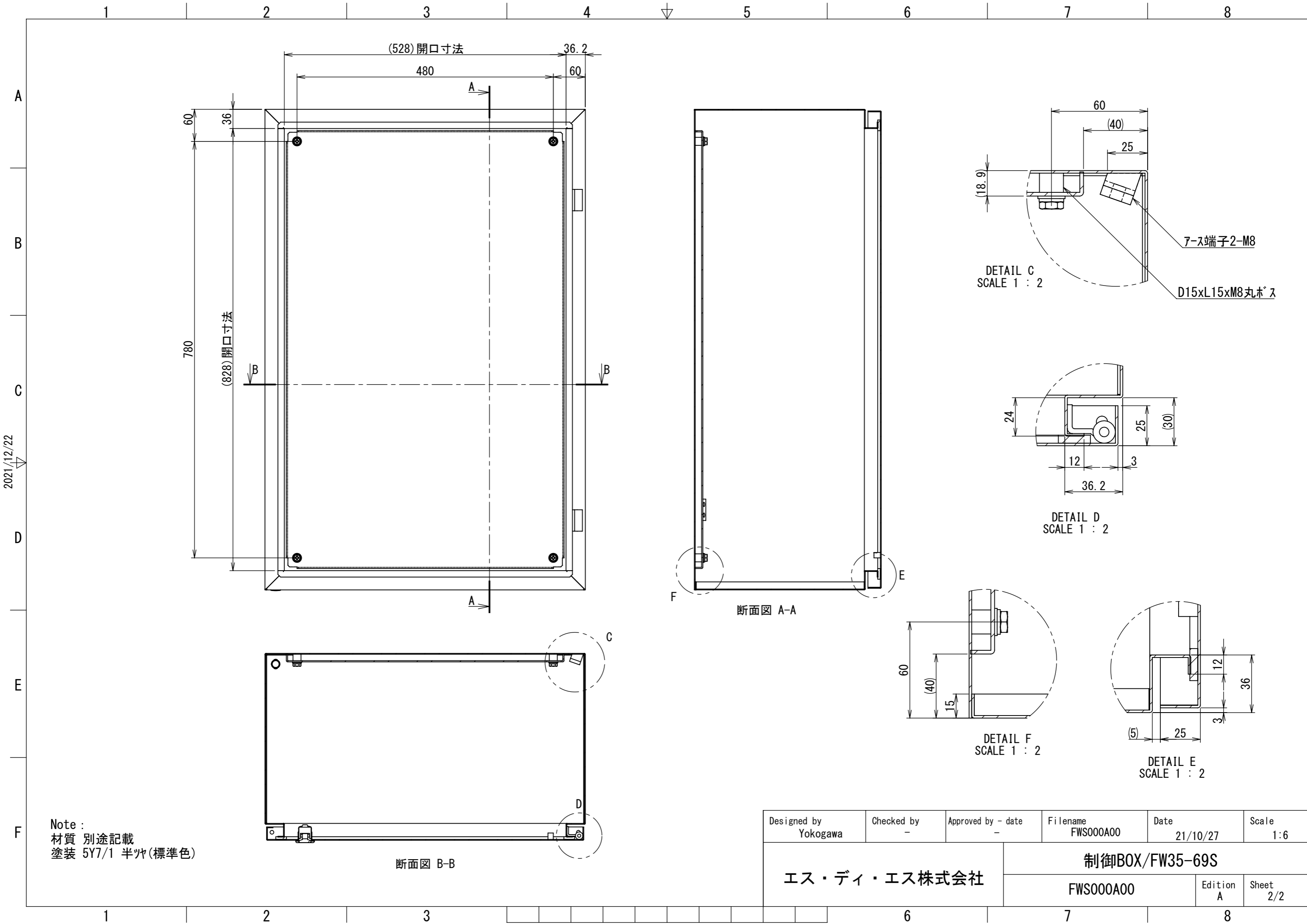

2021/12/22

Note :
 材質 別途記載
 塗装 5Y7/1 半ツヤ(標準色)

Designed by Yokogawa	Checked by -	Approved by - date -	Filename FWS000A00	Date 21/10/27	Scale 1:6
エス・ディ・エス株式会社			制御BOX/FW35-69S		
			FWS000A00	Edition A	Sheet 2/2