

REV.	DESCRIPTION	DATE	APPVL.
A	新規作成	21/10/27	

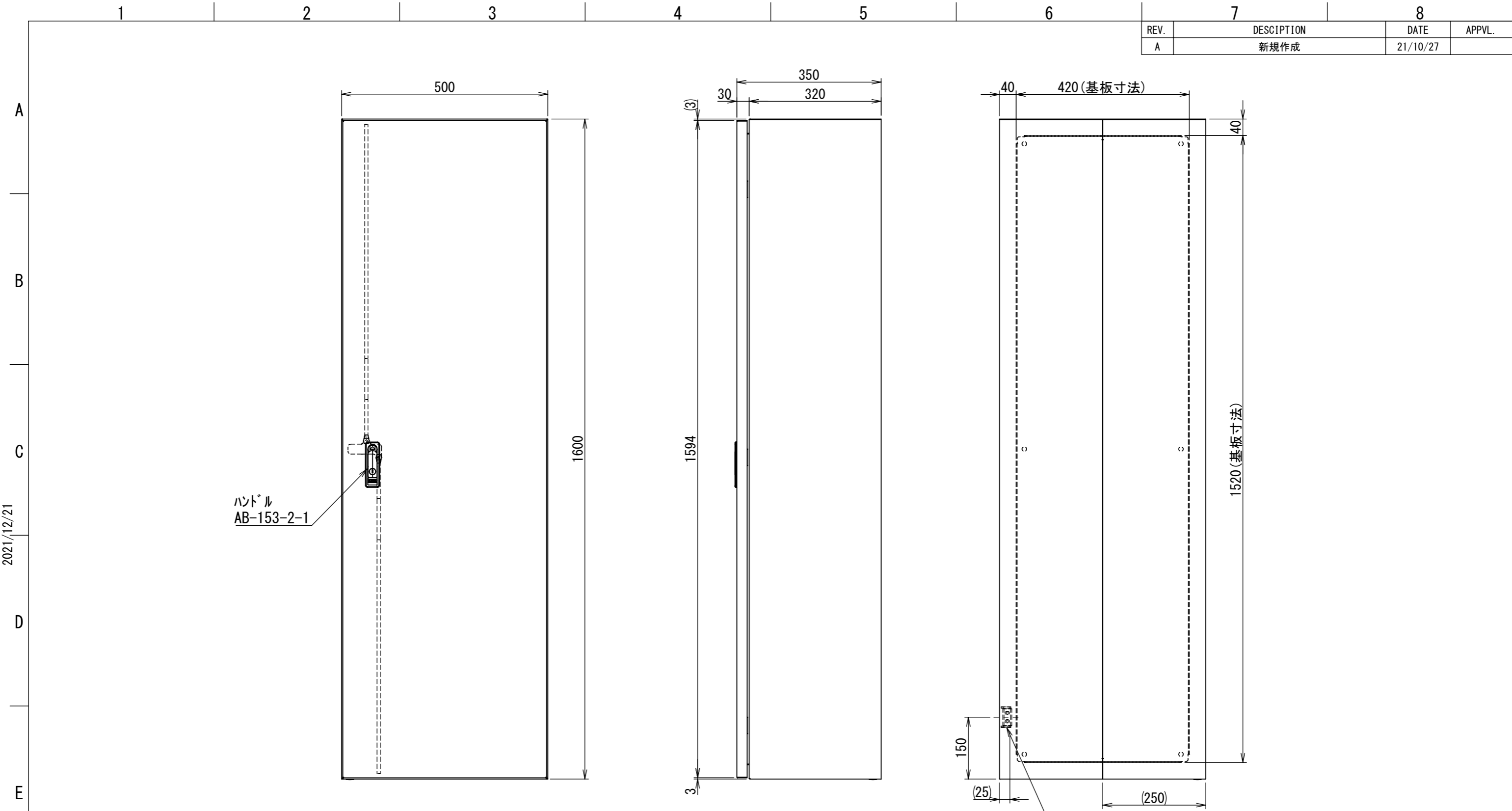

2021/12/21

Note :  
 材質 別途記載  
 塗装 5Y7/1. 半ツヤ(標準色)

Designed by Yokogawa	Checked by -	Approved by - date -	Filename FWS0000A00	Date 21/10/27	Scale 1:9
エス・ディ・エス株式会社			制御BOX/FW35-516S		
			FWS0000A00	Edition A	Sheet 1/2

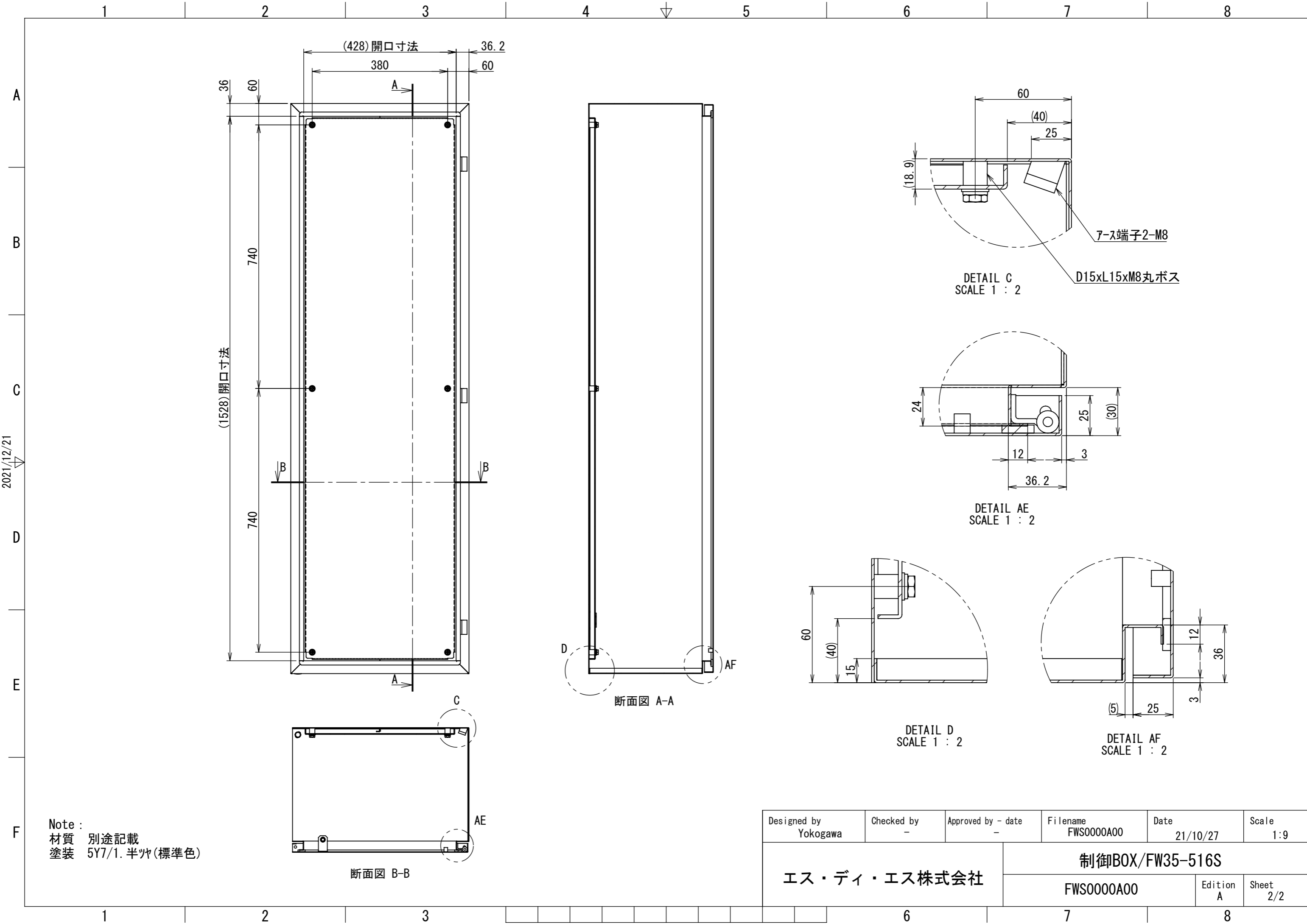

2021/12/21

Note :  
 材質 別途記載  
 塗装 5Y7/1. 半ツヤ (標準色)

Designed by Yokogawa	Checked by -	Approved by - date -	Filename FWS0000A00	Date 21/10/27	Scale 1:9
エス・ディ・エス株式会社			制御BOX/FW35-516S		
			FWS0000A00	Edition A	Sheet 2/2