

REV.	DESCRIPTION	DATE	APPL.
A	新規作成	21/10/27	

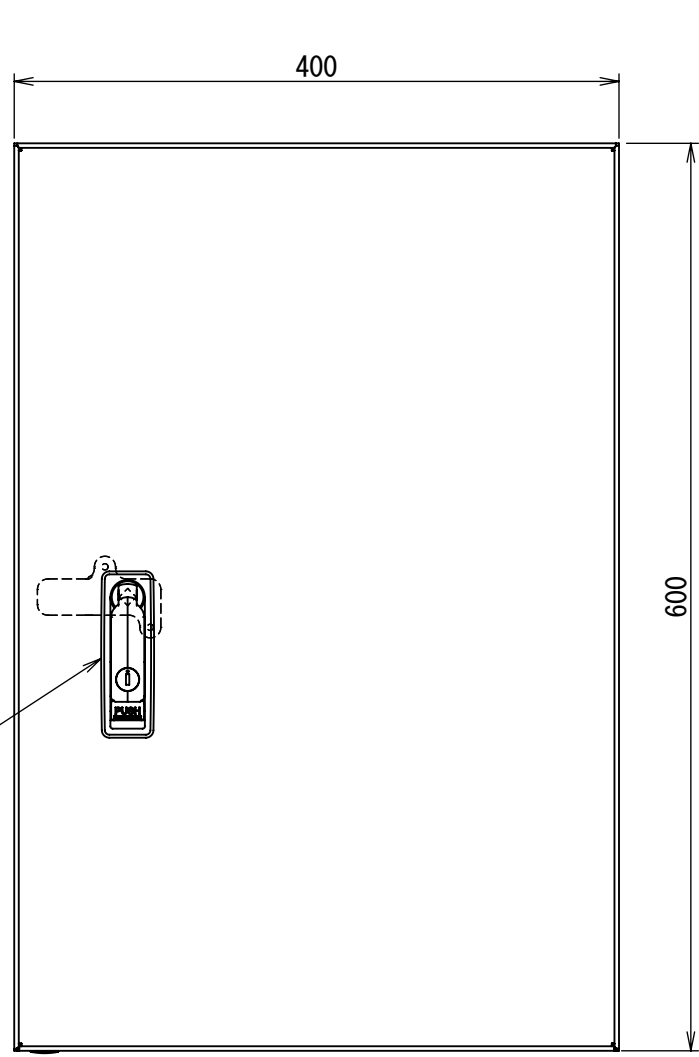

ハンドル
AB-153-2-1

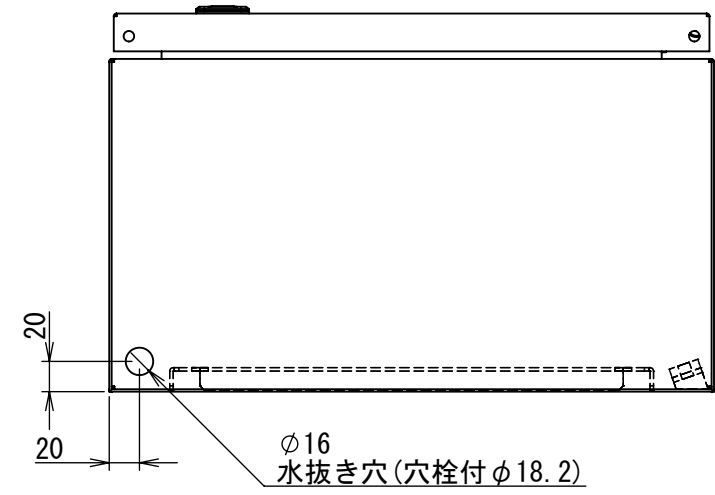
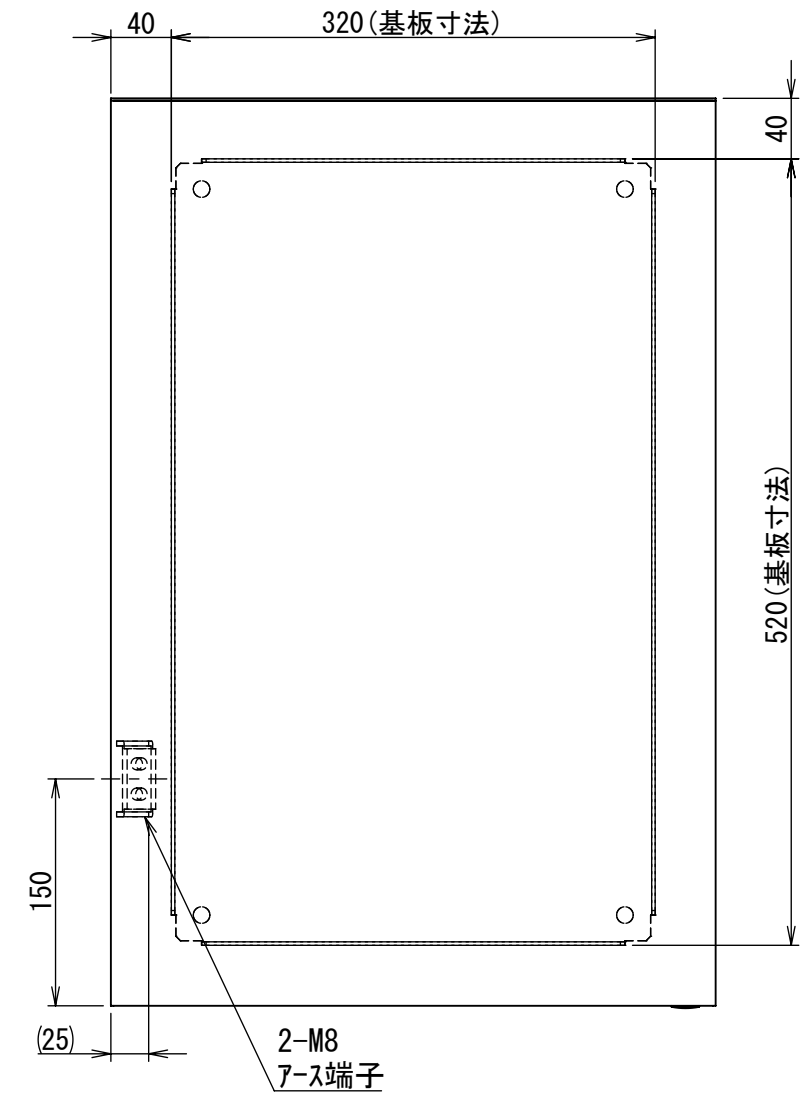
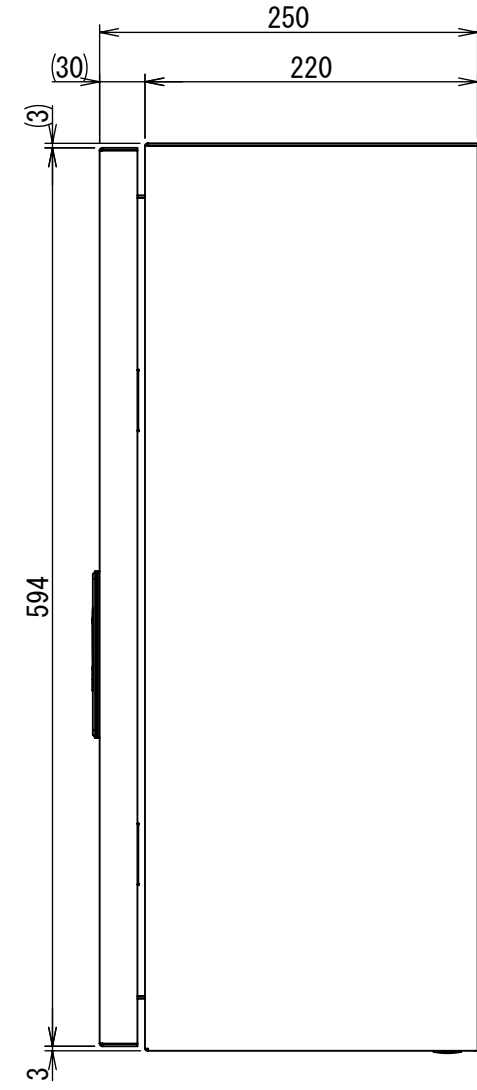

Note :
材質 別途記載
塗装 5Y7/1 半ツヤ(標準色)

Designed by Yokogawa	Checked by -	Approved by - date -	Filename FWS000A00	Date 21/10/27	Scale 1:5
エス・ディ・エス株式会社			制御BOX/FW25-46S		
			FWS000A00	Edition A	Sheet 1/2

2021/12/09

A
B
C
D
E
F

A
B
C
D
E
F

1 2 3 4 5 6 7 8

1 2 3 4 5 6 7 8

2021/12/09

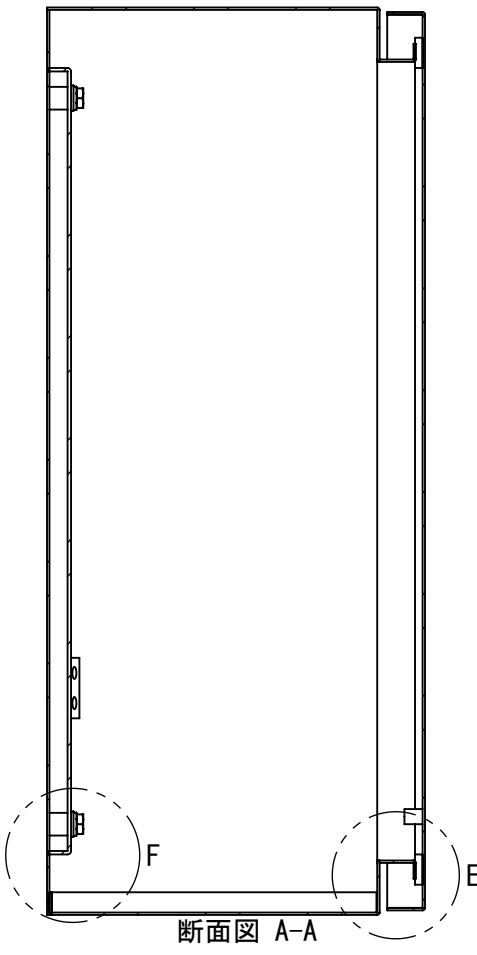
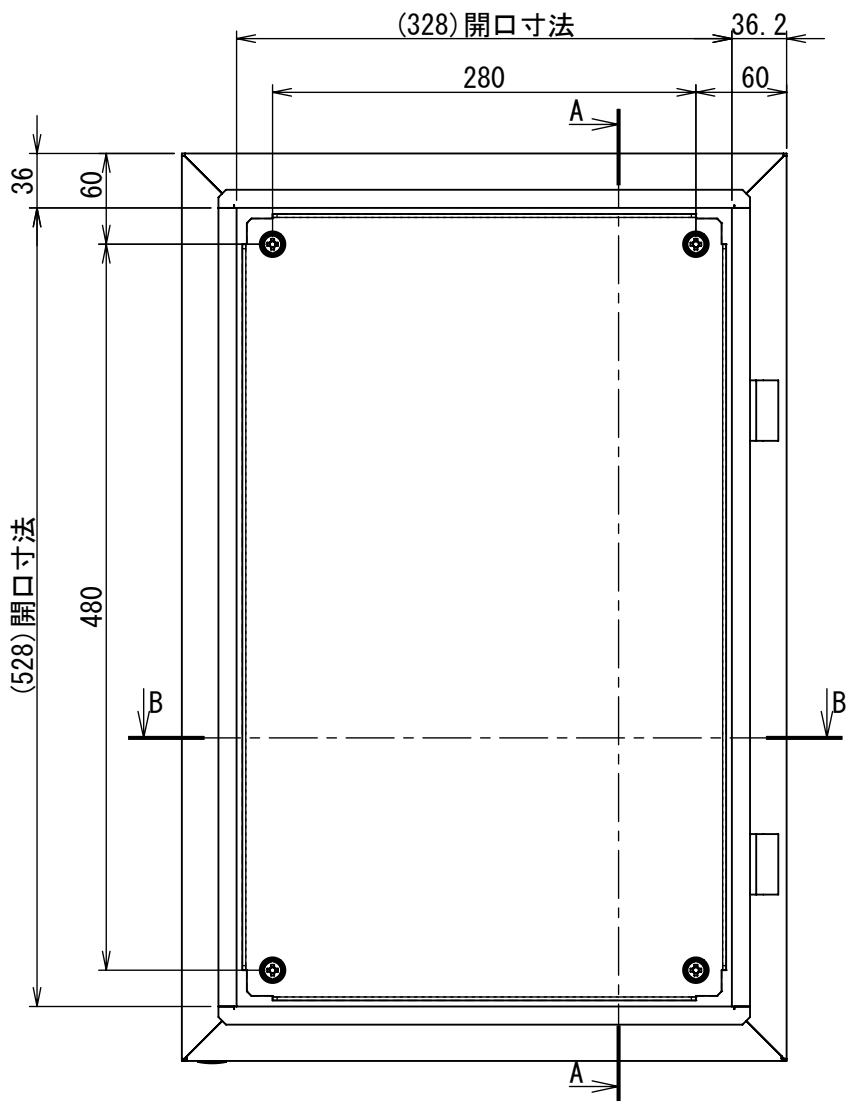

断面図 A-A

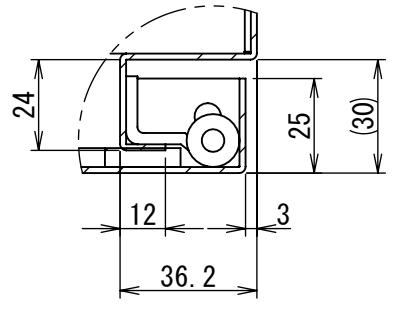
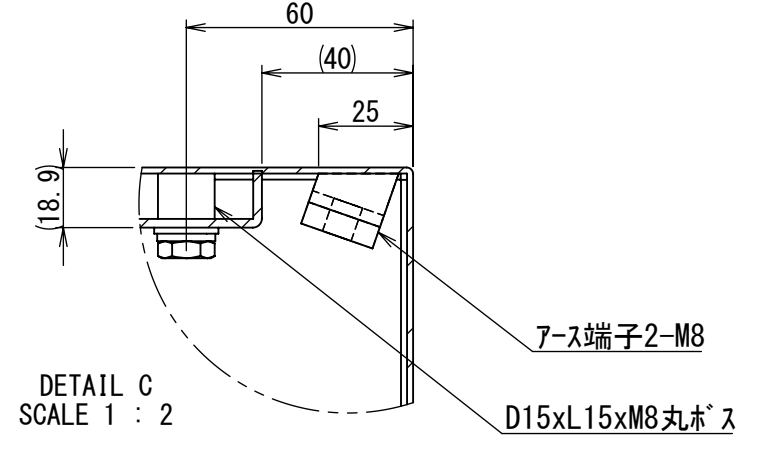

DETAIL D
SCALE 1 : 2

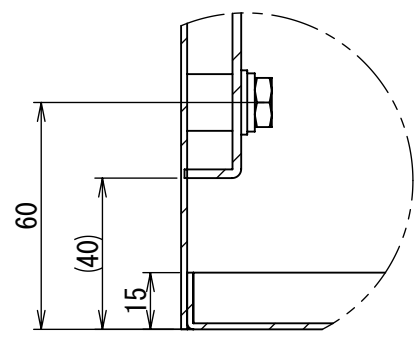

DETAIL F
SCALE 1 : 2

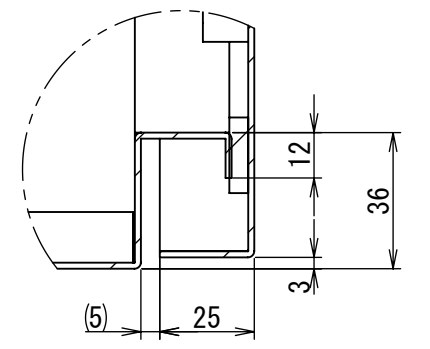

DETAIL E
SCALE 1 : 2

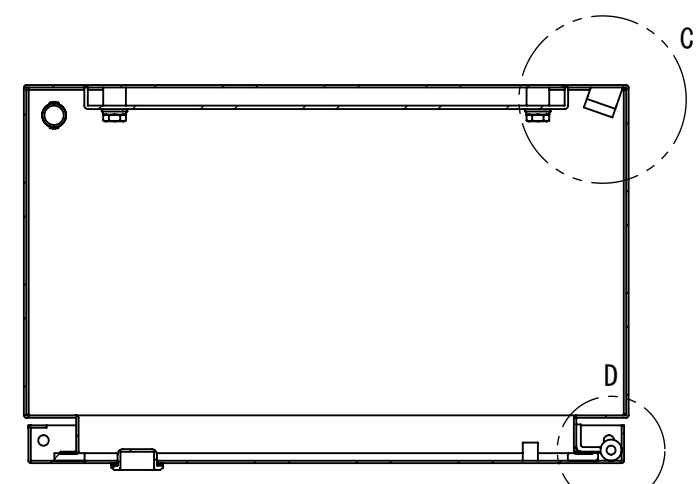

断面図 B-B

Note :
材質 別途記載
塗装 5Y7/1 半ツヤ(標準色)

Designed by Yokogawa	Checked by -	Approved by - date -	Filename FWS000A00	Date 21/10/27	Scale 1:5
エス・ディ・エス株式会社			制御BOX/FW25-46S		
			FWS000A00	Edition A	Sheet 2/2