

2021/11/29

REV.	DESCRIPTION	DATE	APPVL.
A	新規作成	21/10/27	

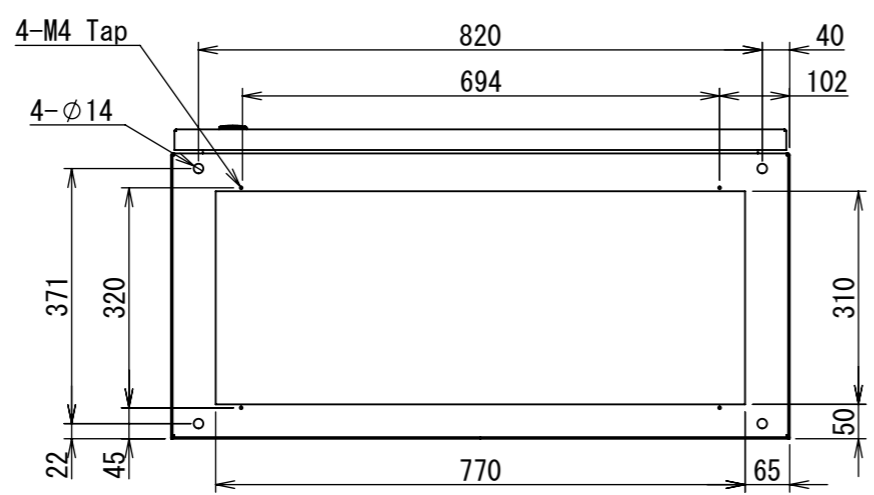
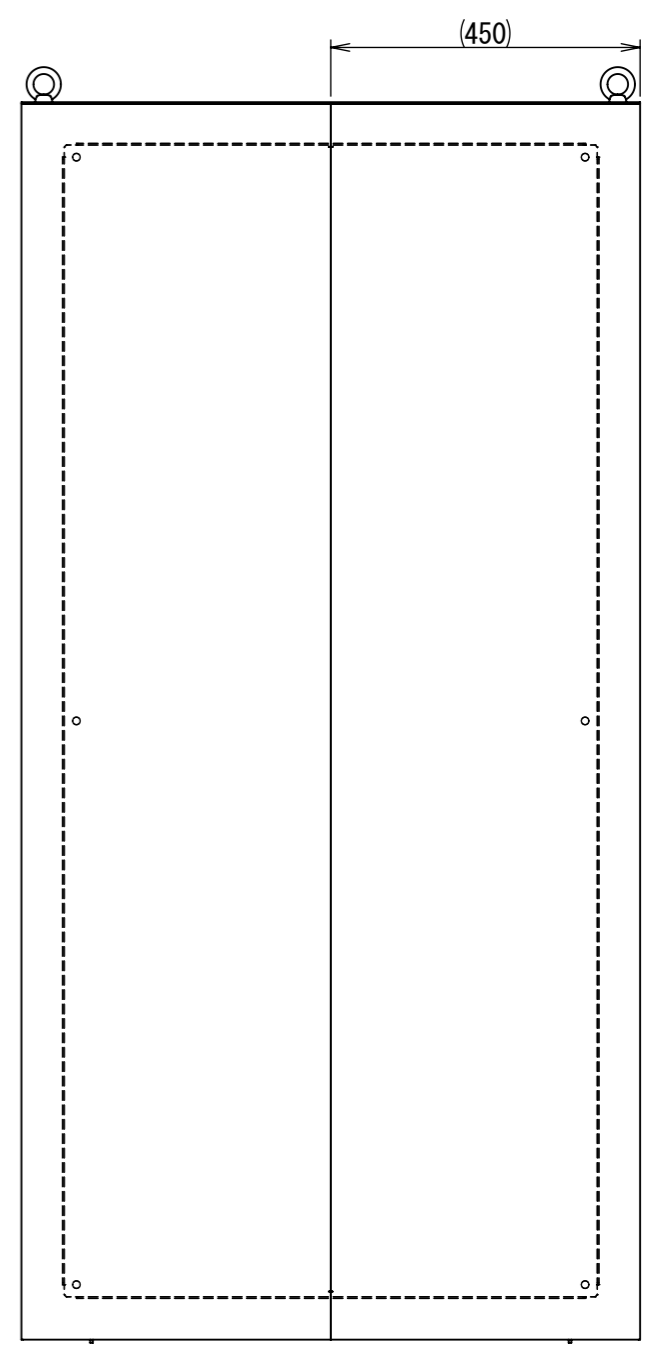
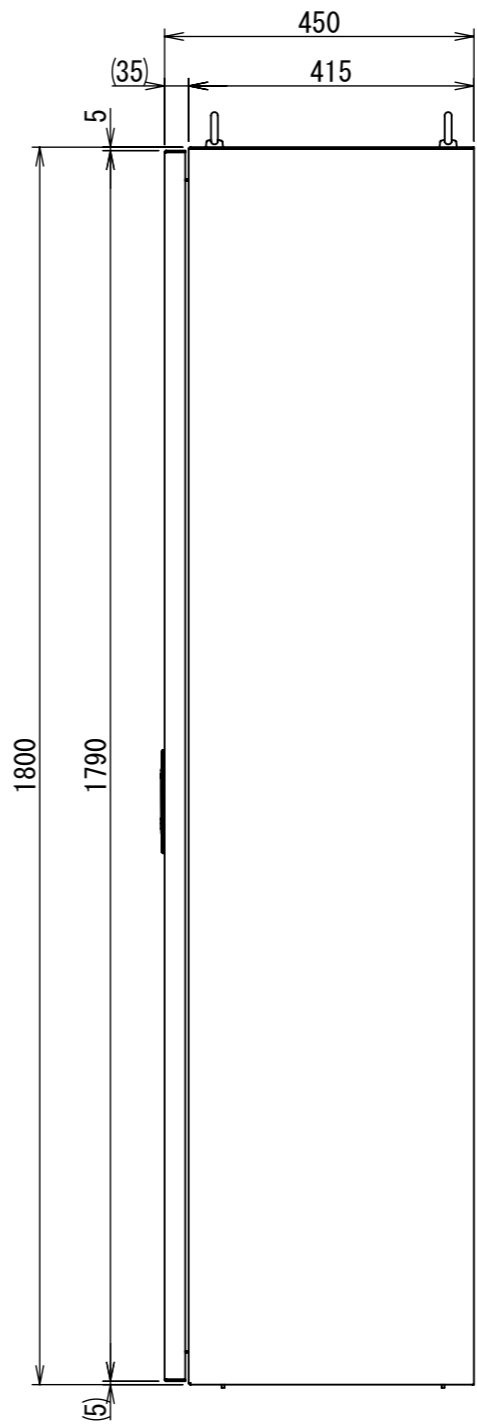
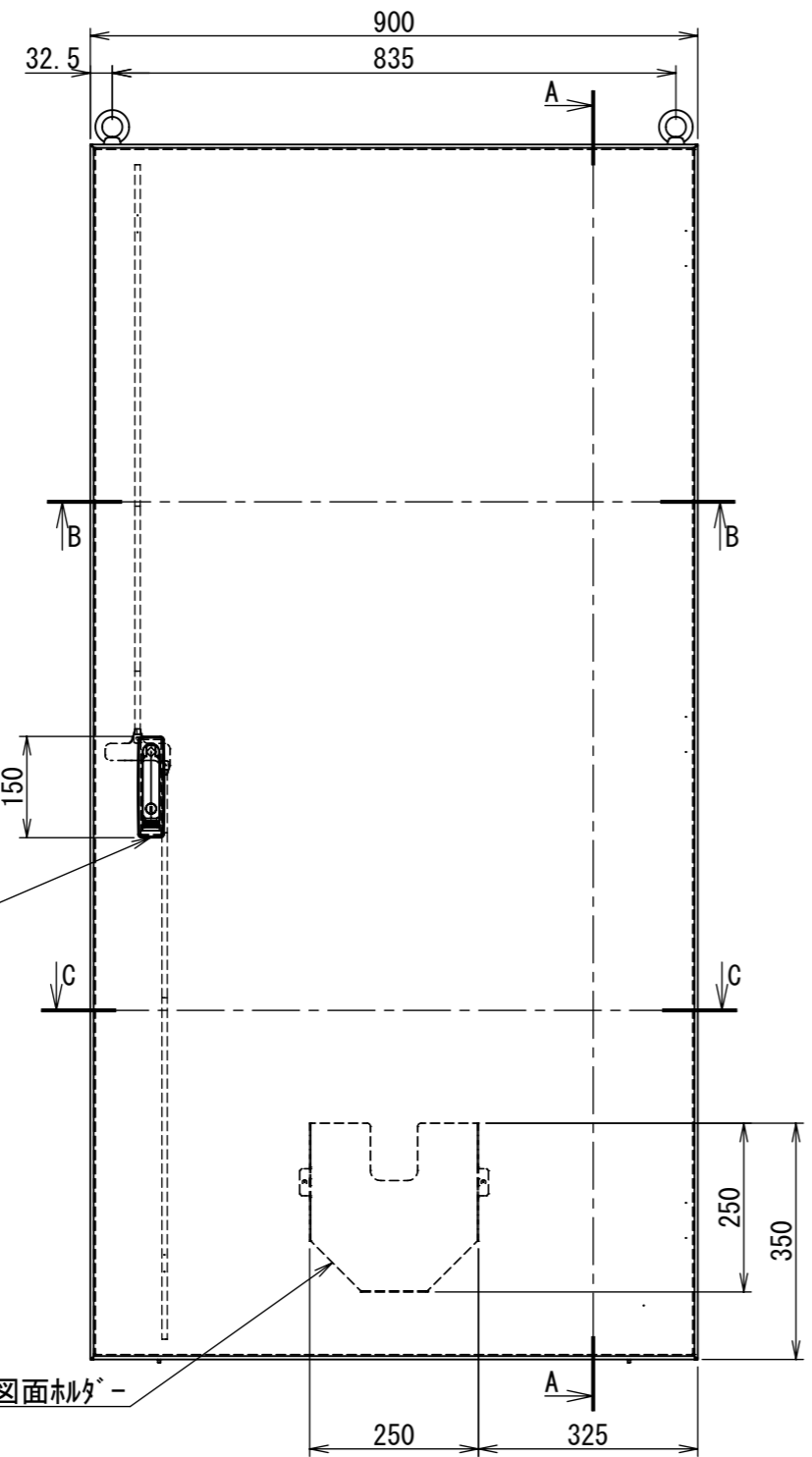

Note :
 材質 別途記載
 塗装 5Y7/1. 半ツヤ(標準色)

Designed by Yokogawa	Checked by -	Approved by - date -	Filename FES000A00	Date 21/10/27	Scale 1:11
エス・ディ・エス株式会社			自立盤/FE45-918S		
			FES000A00	Edition A	Sheet 1/2

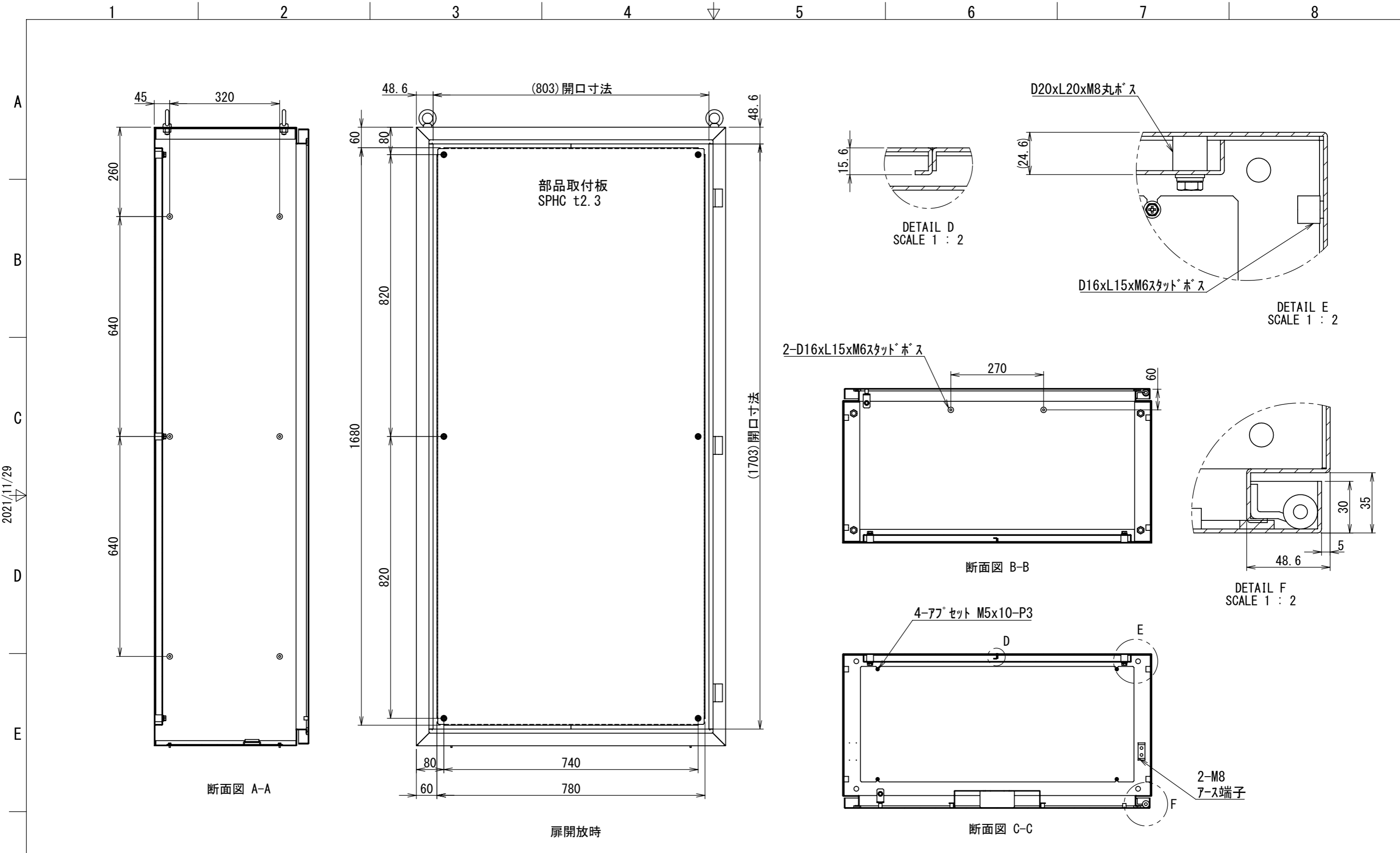

2021/11/29

Note :
 材質 別途記載
 塗装 5Y7/1. 半ツヤ(標準色)

Designed by Yokogawa	Checked by -	Approved by - date -	Filename FES000A00	Date 21/10/27	Scale 1:10
エス・ディ・エス株式会社			自立盤/FE45-918S		
			FES000A00	Edition A	Sheet 2/2