

REV.	DESCRIPTION	DATE	APPL.
A	新規作成	2021/10/27	

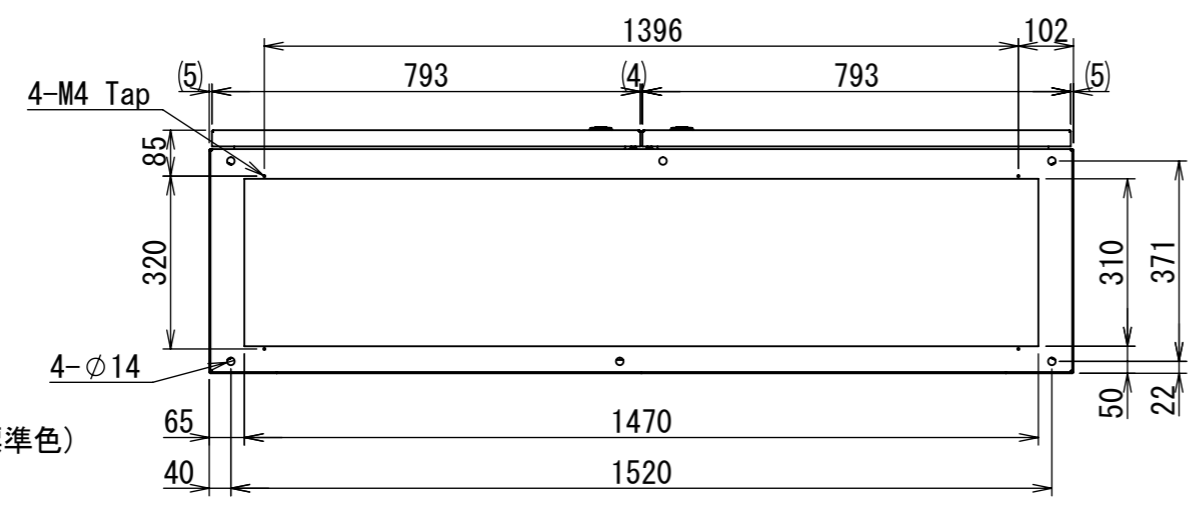
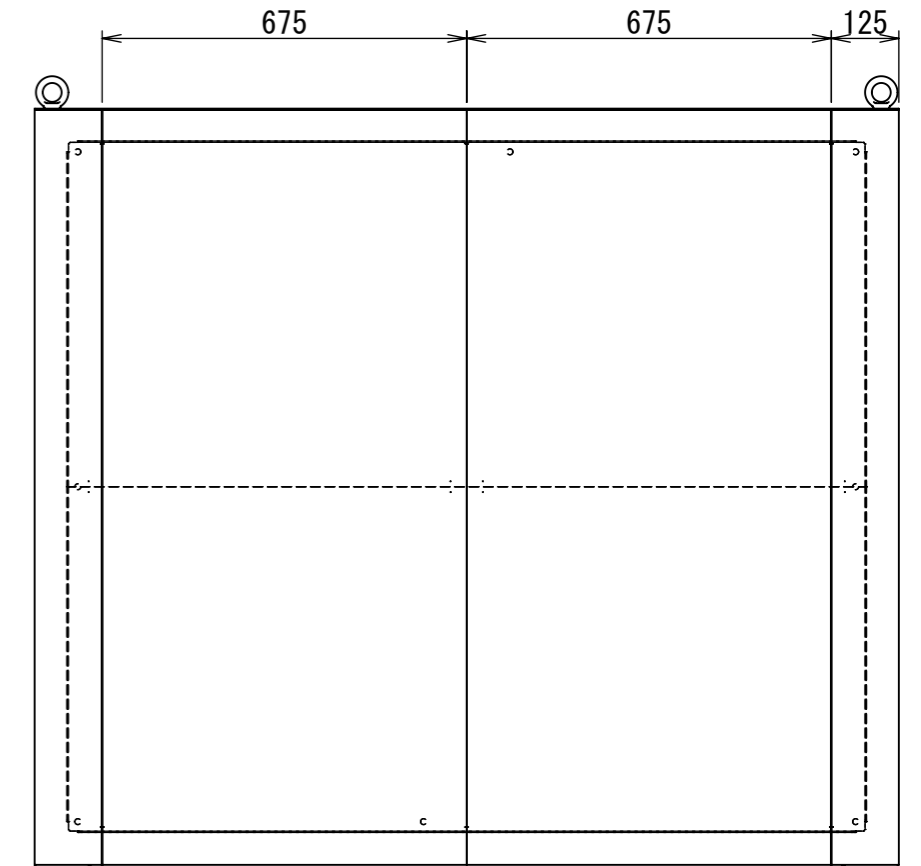
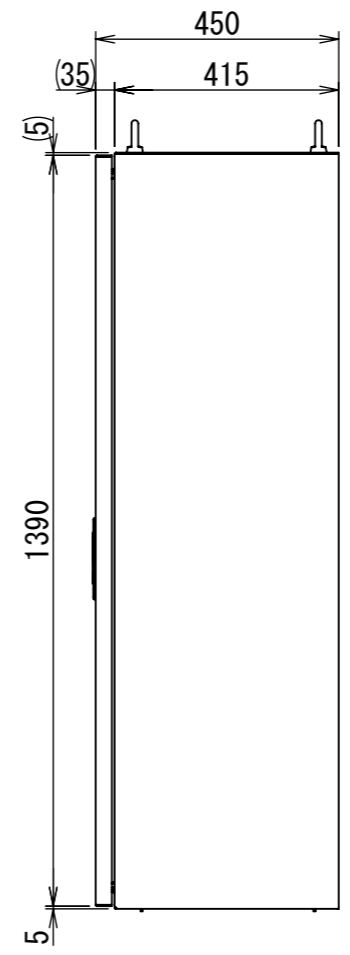
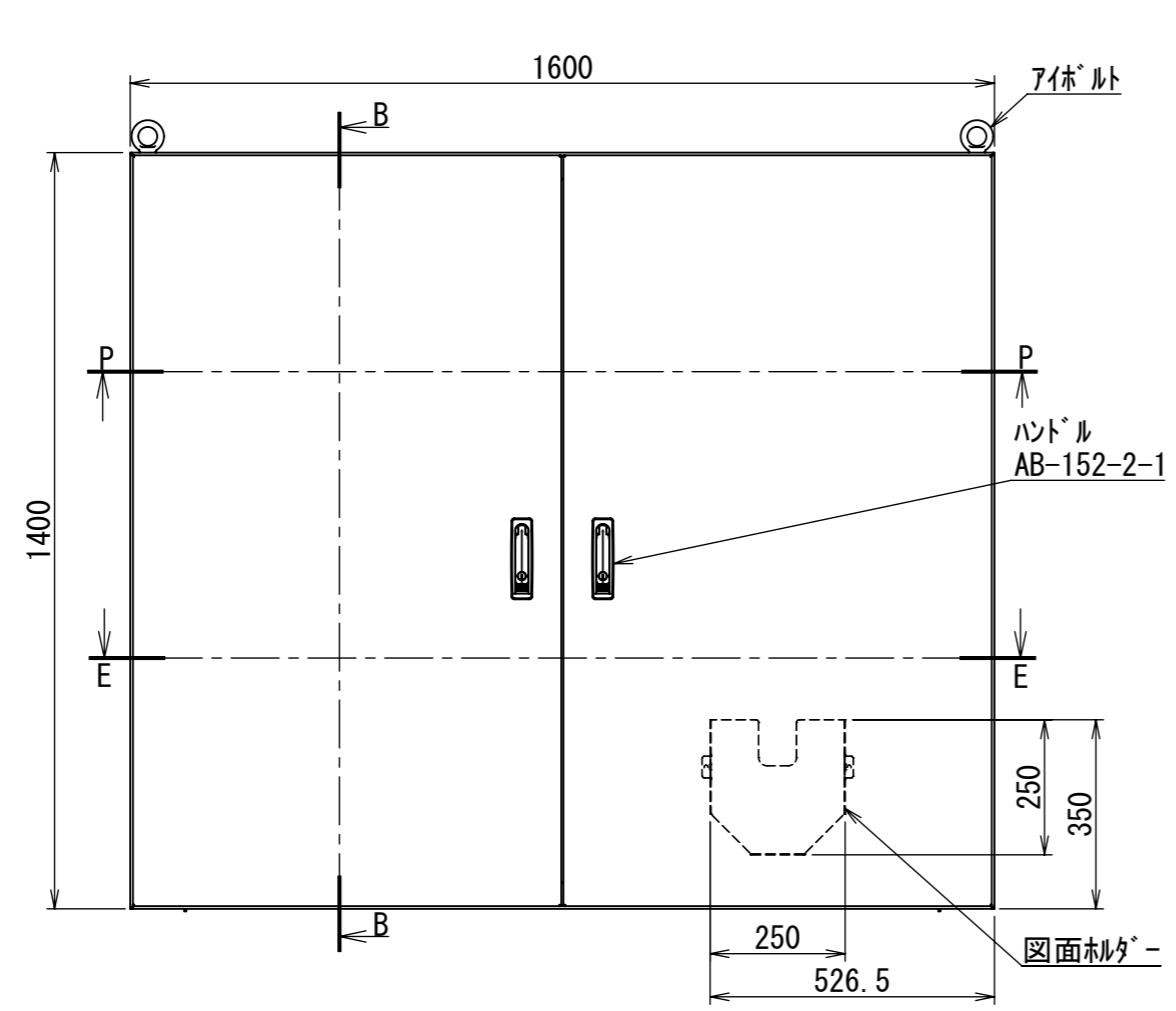
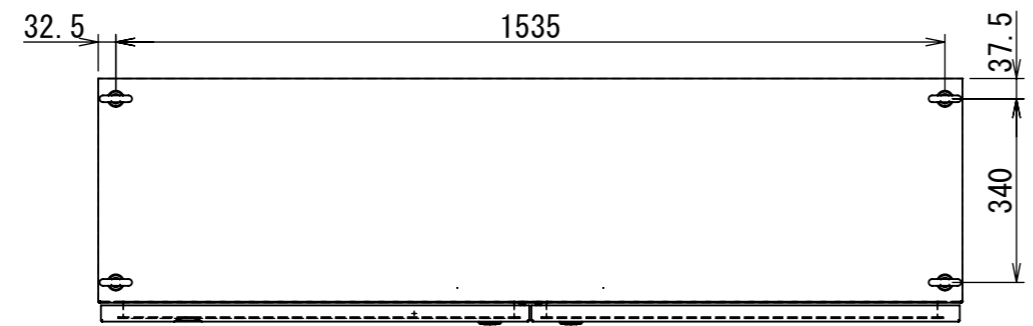

Note :
 材質 別途記載
 塗装 5Y7/1. 半ツヤ(標準色)

Designed by Yokogawa	Checked by -	Approved by - date -	Filename FEWP00000A00a	Date 21/10/27	Scale 1:14
エス・ディ・エス株式会社			自立制御盤/FE45-1614WP		
			FEWP00000A00	Edition A	Sheet 1/2

2021/12/08

2021/12/08

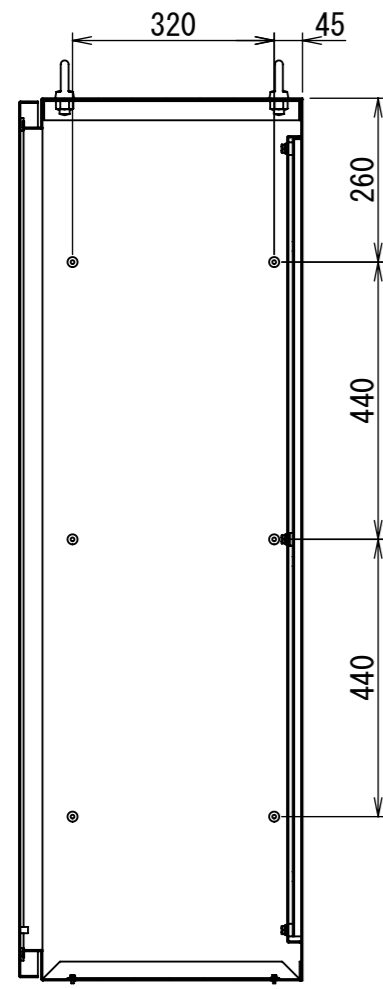

断面図 B-B

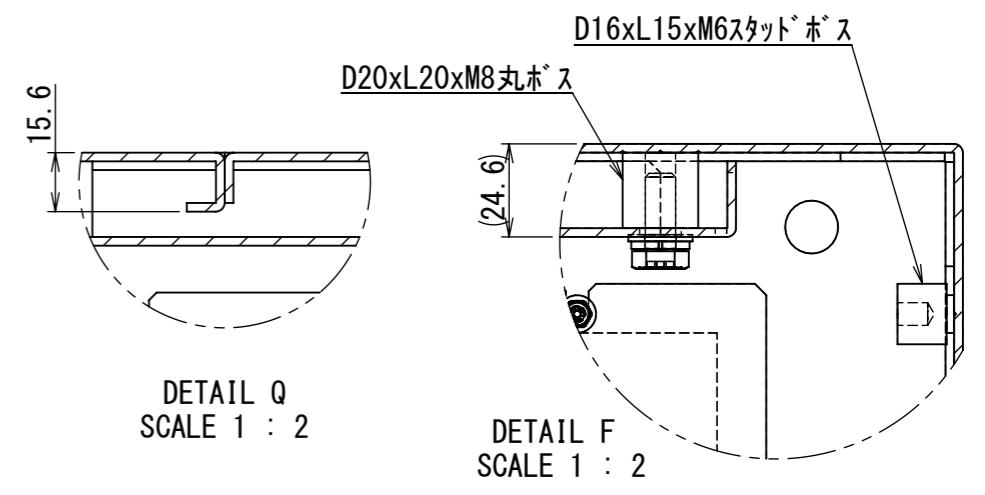
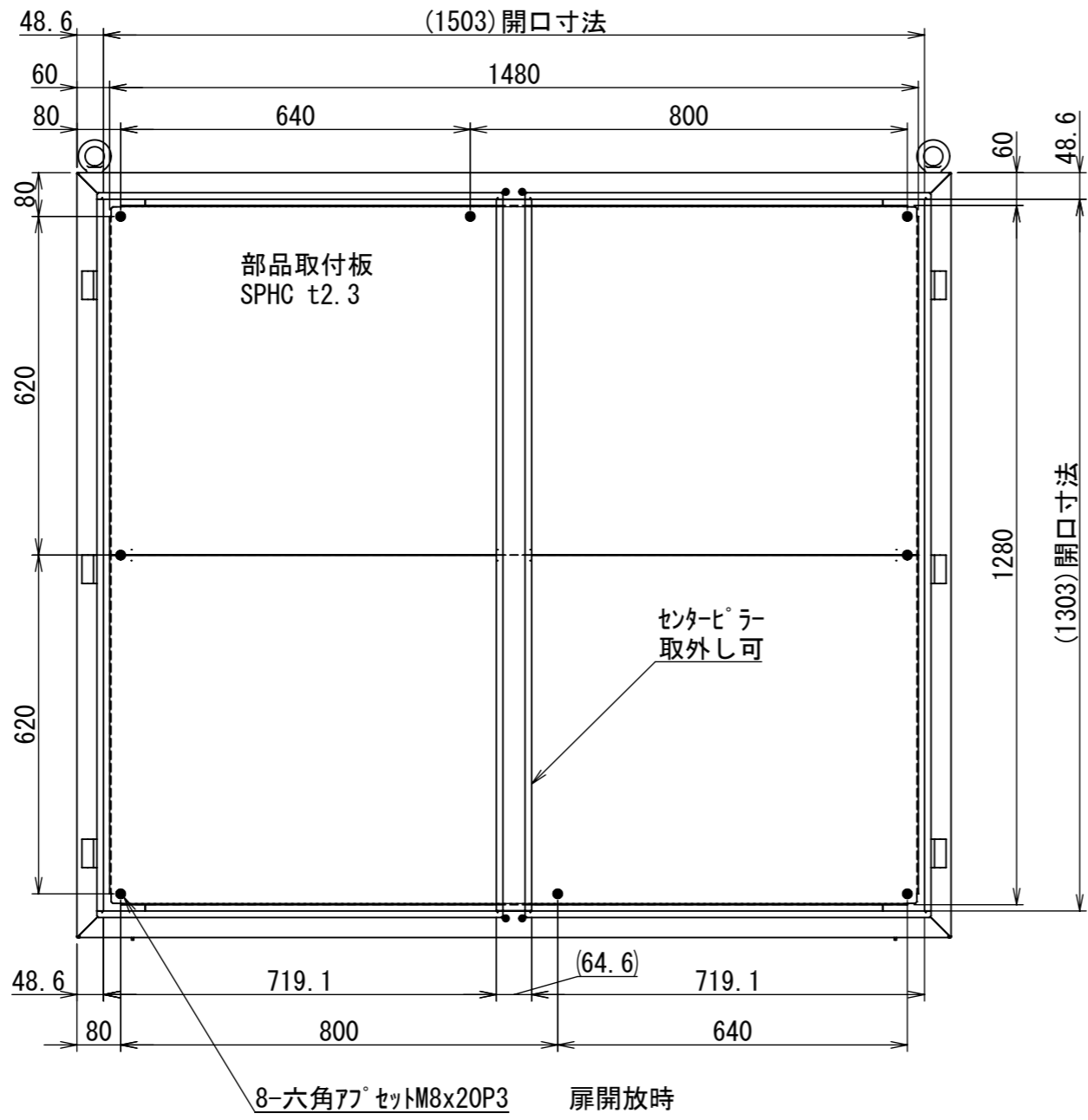

DETAIL Q
SCALE 1 : 2

DETAIL F
SCALE 1 : 2

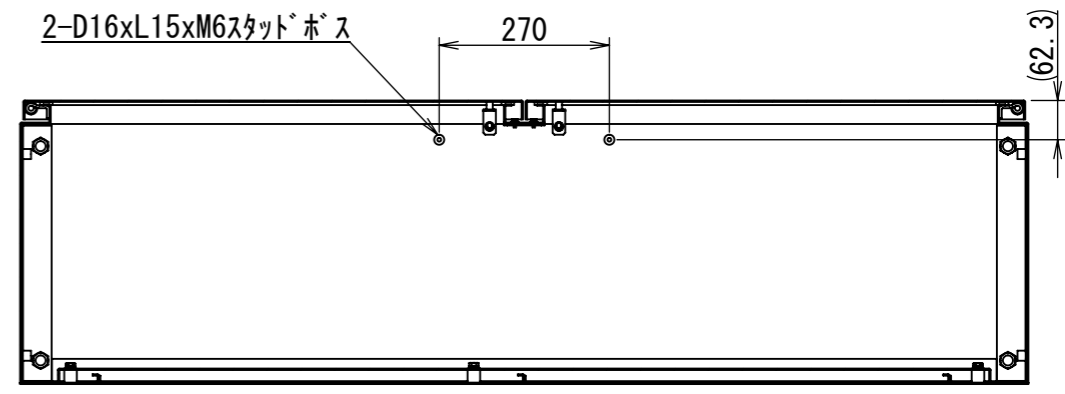

断面図 P-P

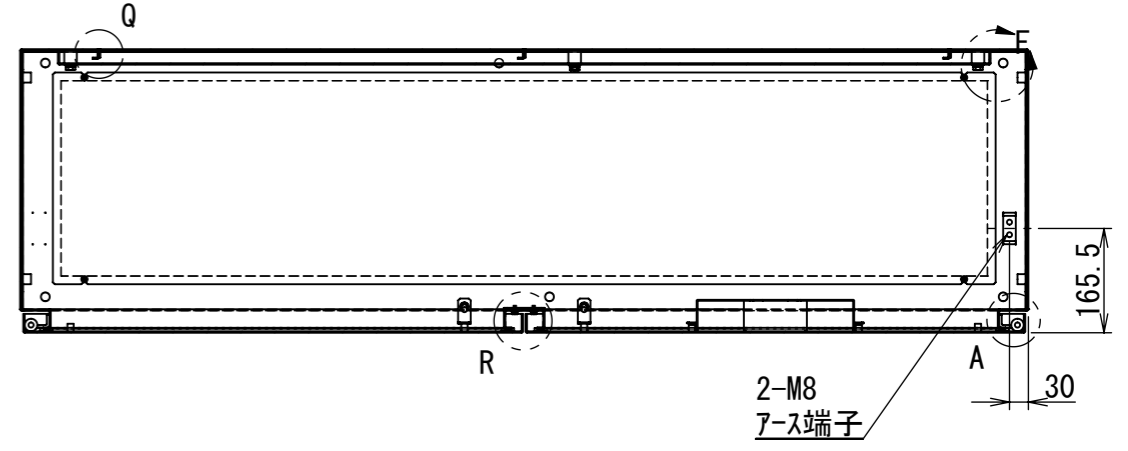

断面図 E-E

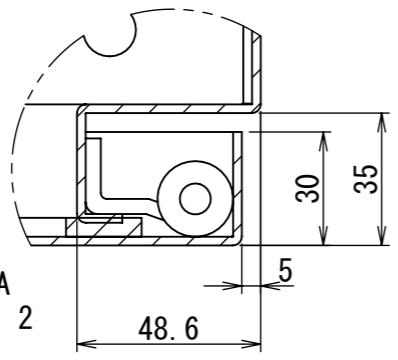

DETAIL A
SCALE 1 : 2

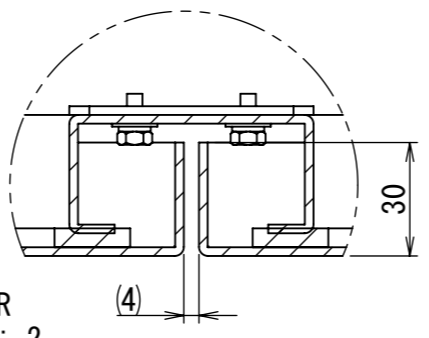

DETAIL R
SCALE 1 : 2

Note :
材質 別途記載
塗装 5Y7/1. 半ツヤ(標準色)

Designed by Yokogawa	Checked by -	Approved by - date -	Filename FEWP00000A00a	Date 21/10/27	Scale 1:12
エス・ディ・エス株式会社			自立制御盤/FE45-1614WP		
			FEWP00000A00	Edition A	Sheet 2/2