

REV.	DESCRIPTION	DATE	APPL.
A	新規作成	21/10/27	

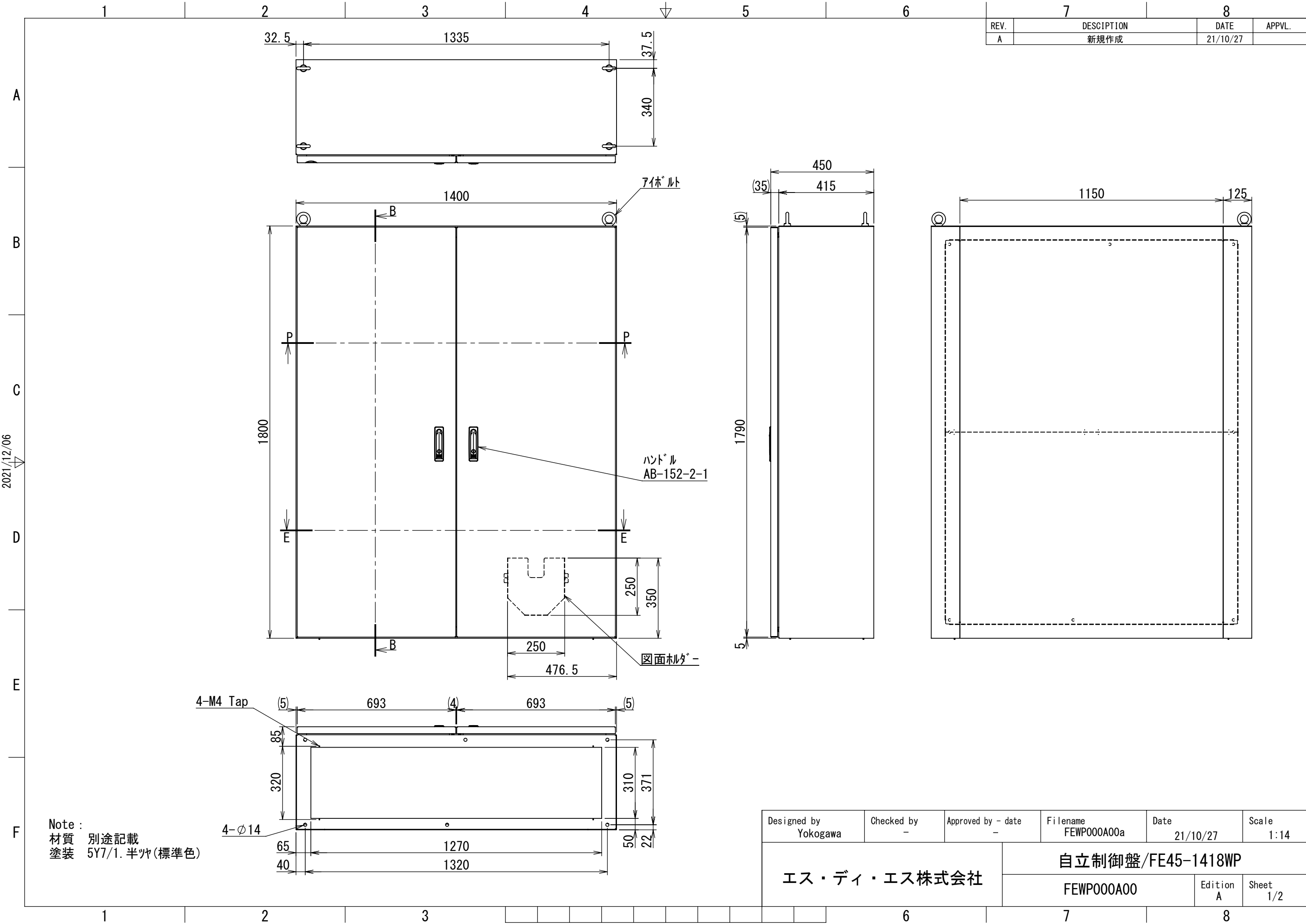

2021/12/06

Note :
 材質 別途記載
 塗装 5Y7/1. 半ツヤ(標準色)

Designed by Yokogawa	Checked by -	Approved by - date -	Filename FEWP000A00a	Date 21/10/27	Scale 1:14
エス・ディ・エス株式会社			自立制御盤/FE45-1418WP		
			FEWP000A00	Edition A	Sheet 1/2

2021/12/06

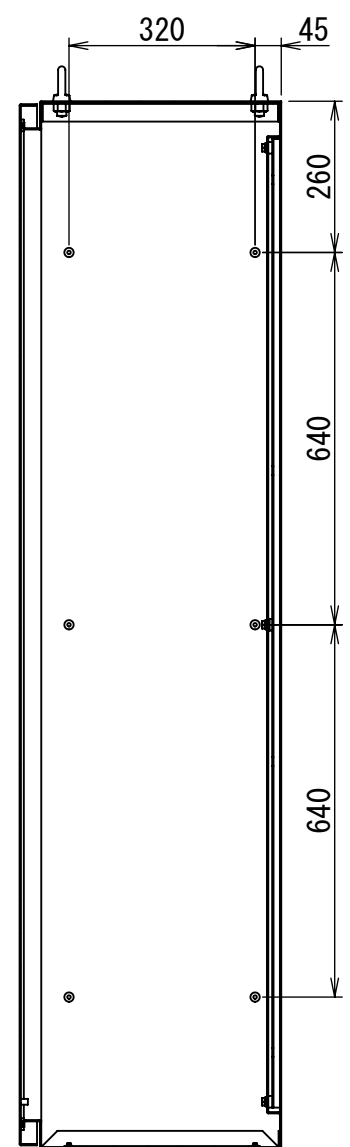

断面図 B-B

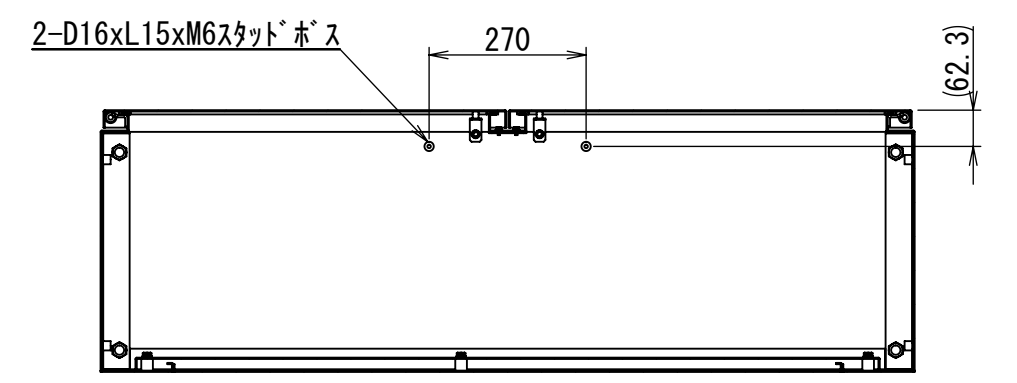
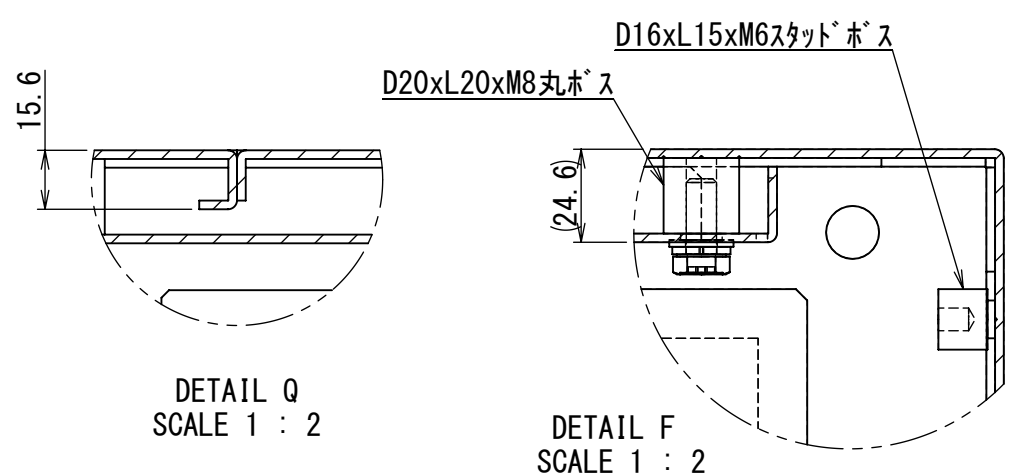
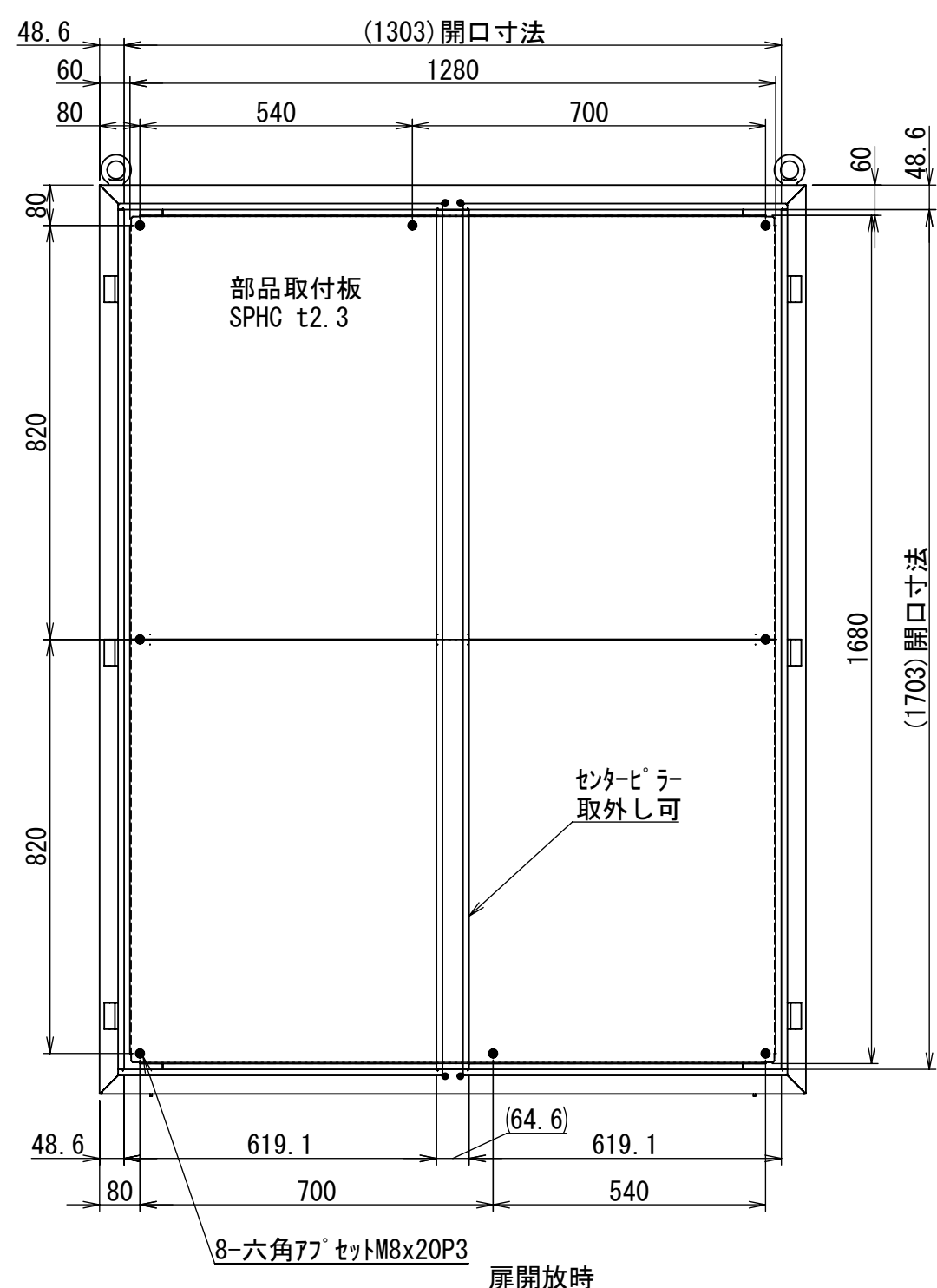

断面図 P-P

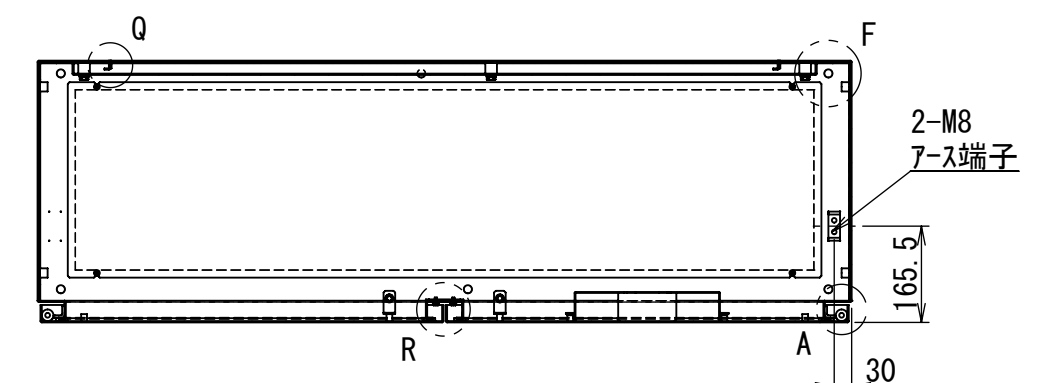

断面図 E-E

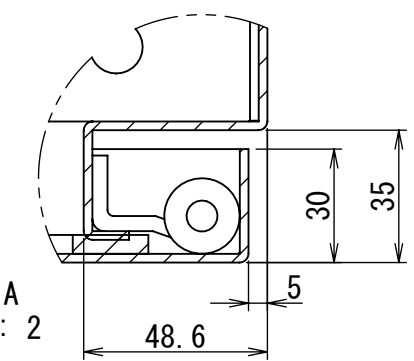

DETAIL A SCALE 1 : 2

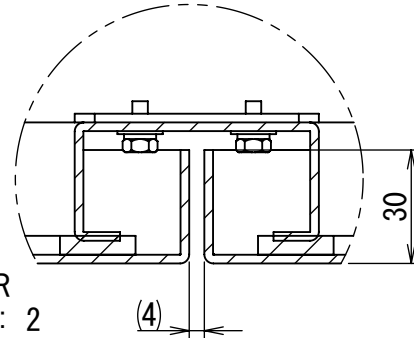

DETAIL R SCALE 1 : 2

Note :
 材質 別途記載
 塗装 5Y7/1. 半ツヤ(標準色)

Designed by Yokogawa	Checked by -	Approved by - date -	Filename FEWP000A00a	Date 21/10/27	Scale 1:13
エス・ディ・エス株式会社			自立制御盤/FE45-1418WP		
			FEWP000A00	Edition A	Sheet 2/2