

REV.	DESCRIPTION	DATE	APPL.
A	新規作成	21/10/27	

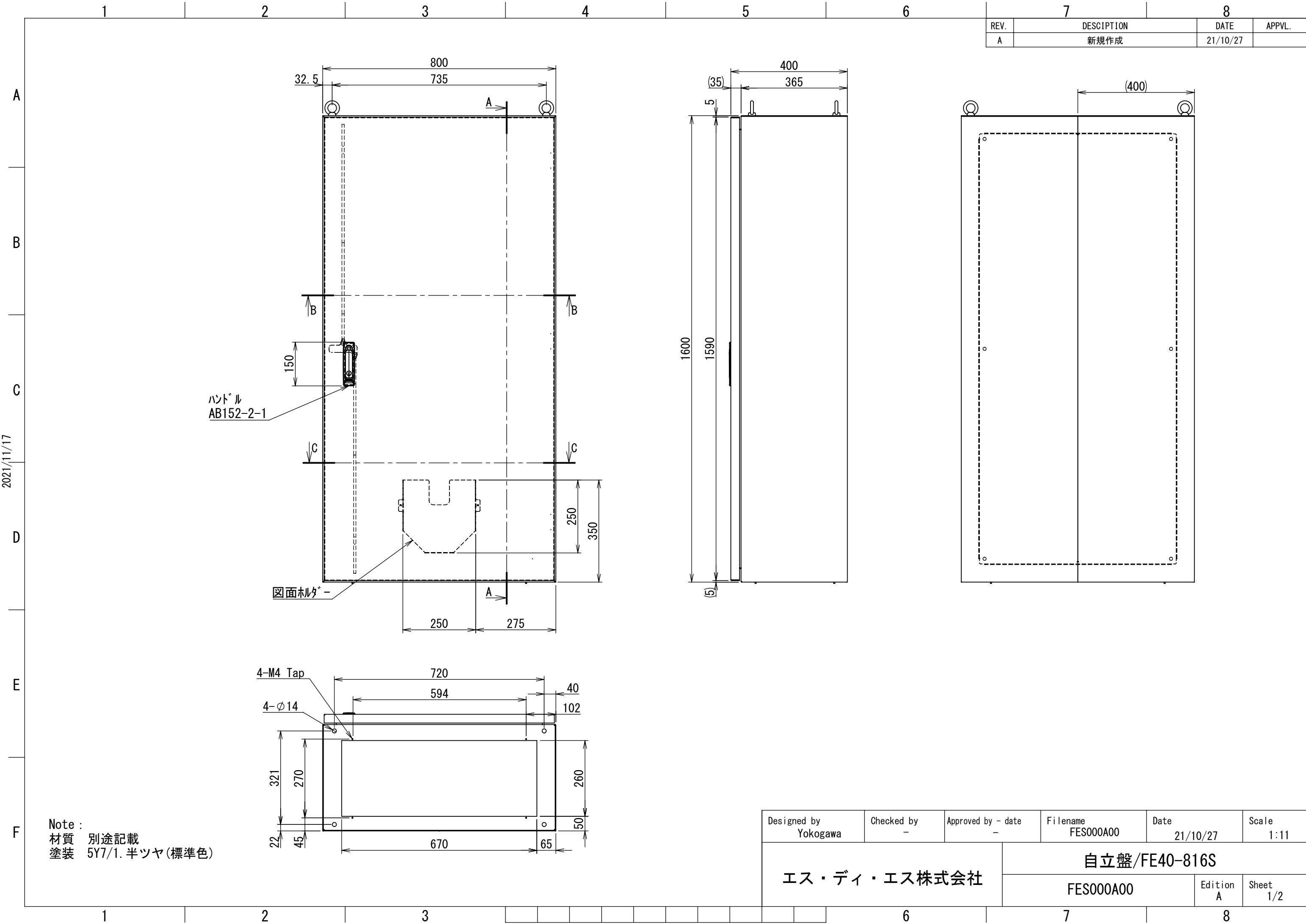

2021/11/17

Note :  
 材質 別途記載  
 塗装 5Y7/1. 半ツヤ(標準色)

Designed by Yokogawa	Checked by -	Approved by - date -	Filename FES000A00	Date 21/10/27	Scale 1:11
エス・ディ・エス株式会社			自立盤/FE40-816S		
			FES000A00	Edition A	Sheet 1/2

2021/11/17

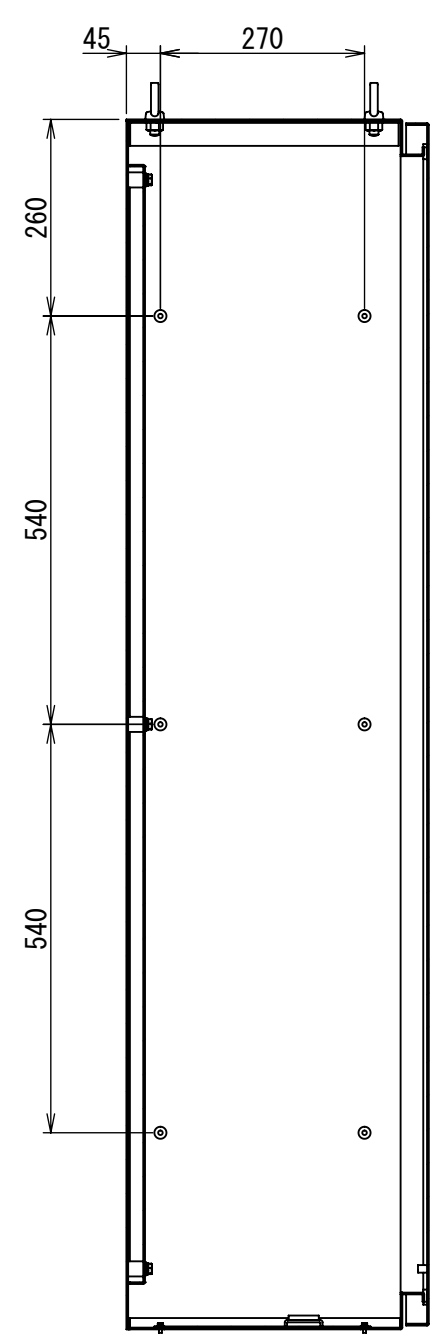

断面図 A-A

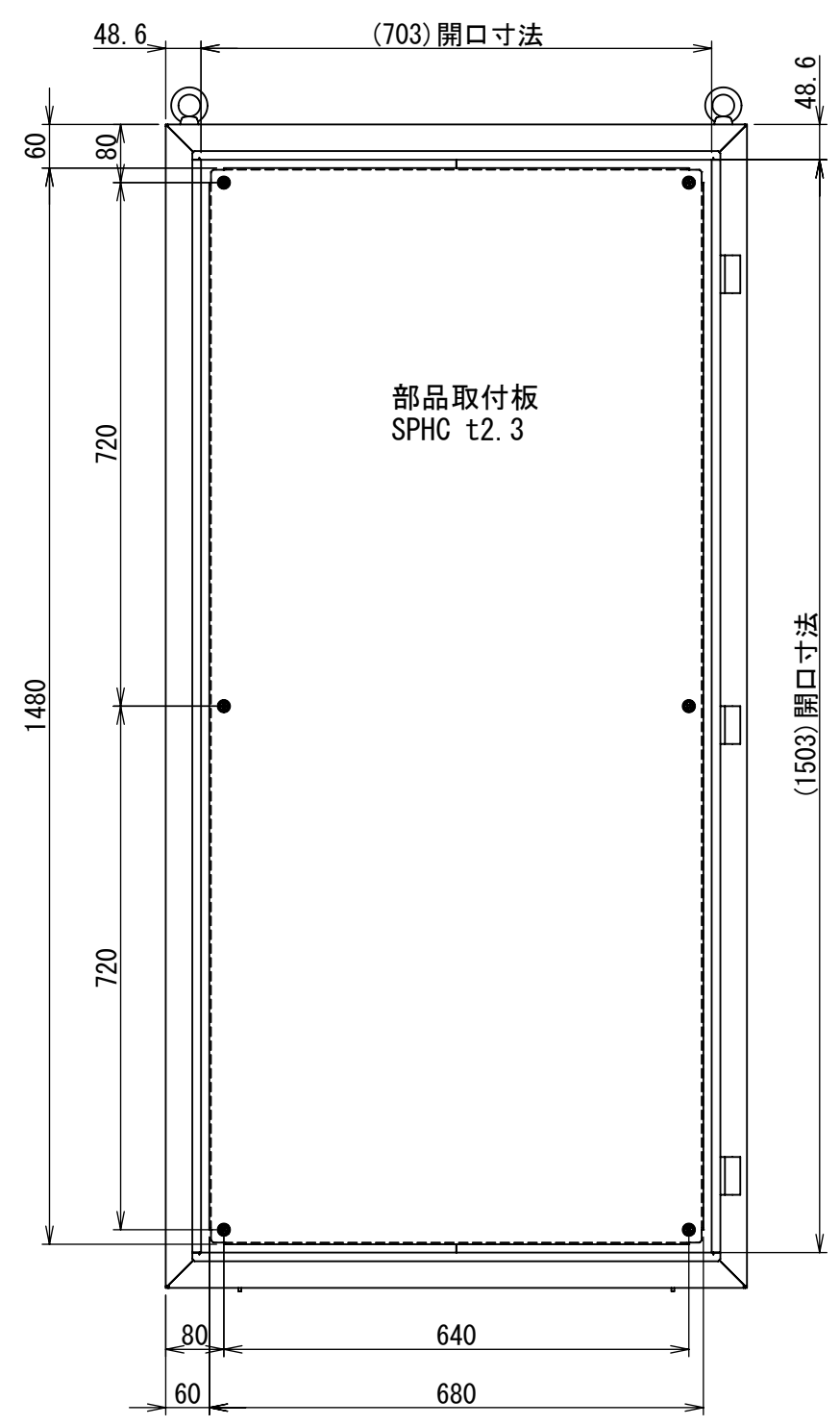

扉開放時

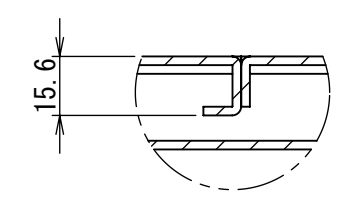

DETAIL D  
SCALE 1 : 2

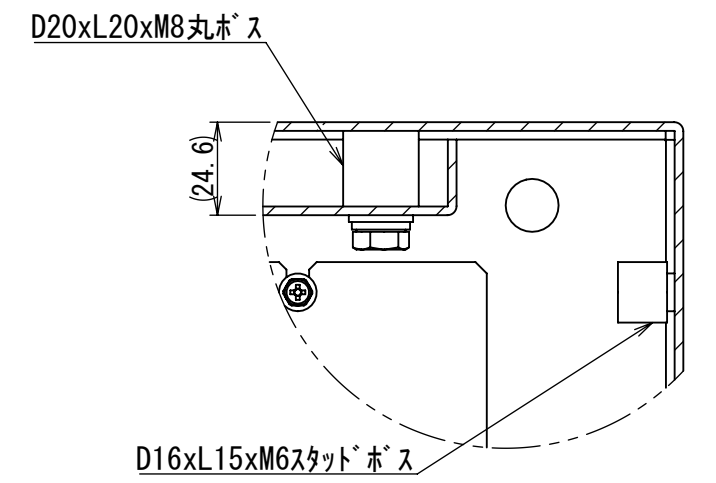

DETAIL E  
SCALE 1 : 2

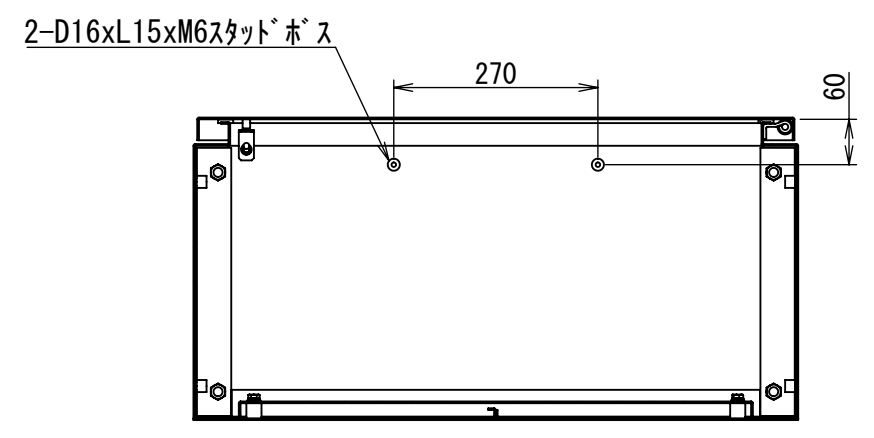

断面図 B-B

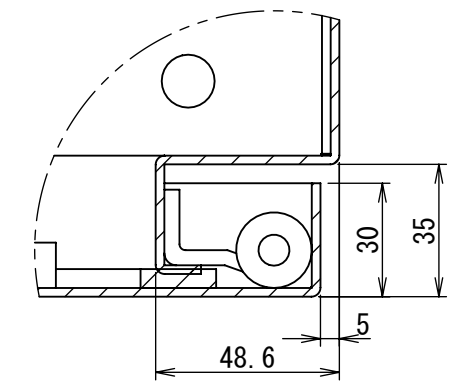

DETAIL F  
SCALE 1 : 2

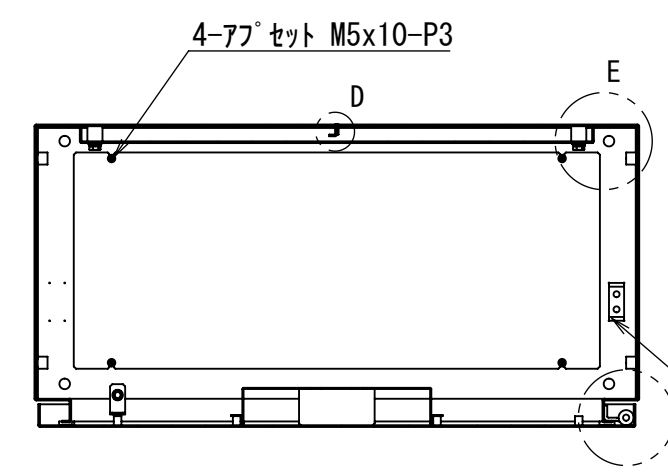

断面図 C-C

Note :  
材質 別途記載  
塗装 5Y7/1. 半ツヤ(標準色)

Designed by Yokogawa	Checked by -	Approved by - date -	Filename FES000A00	Date 21/10/27	Scale 1:10
エス・ディ・エス株式会社			自立盤/FE40-816S		
			FES000A00	Edition A	Sheet 2/2