

REV.	DESCRIPTION	DATE	APPL.
A	新規作成	21/10/27	

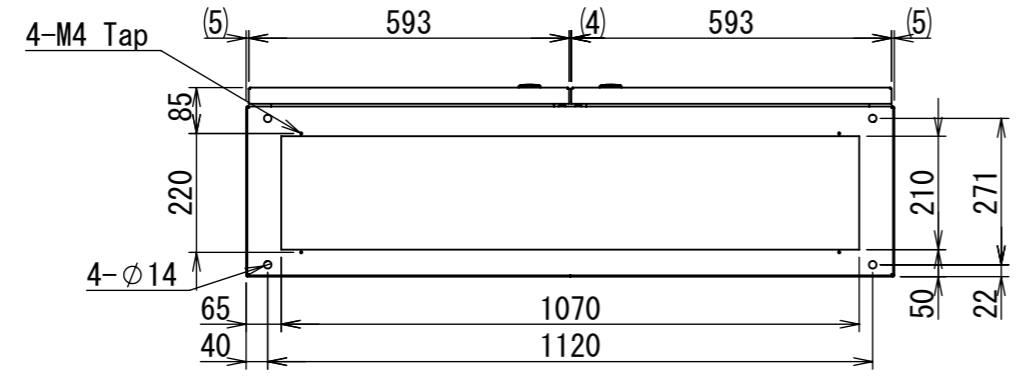
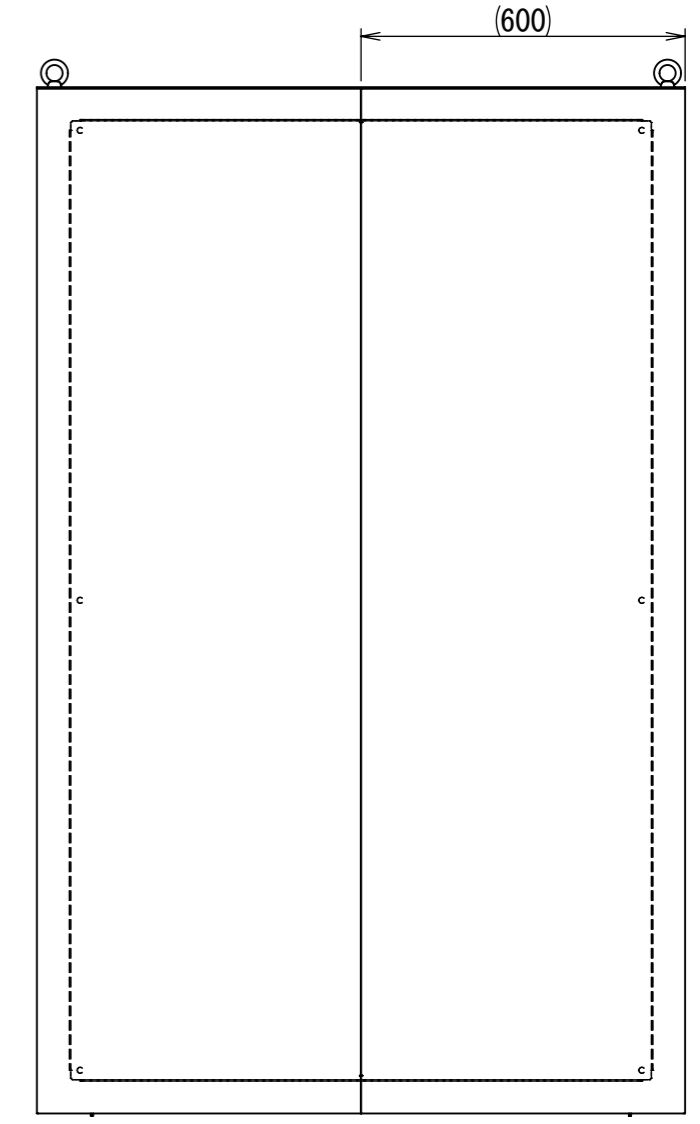
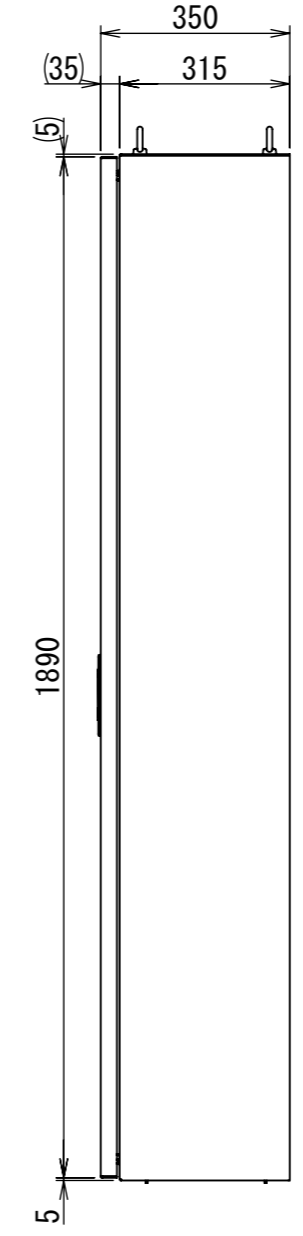
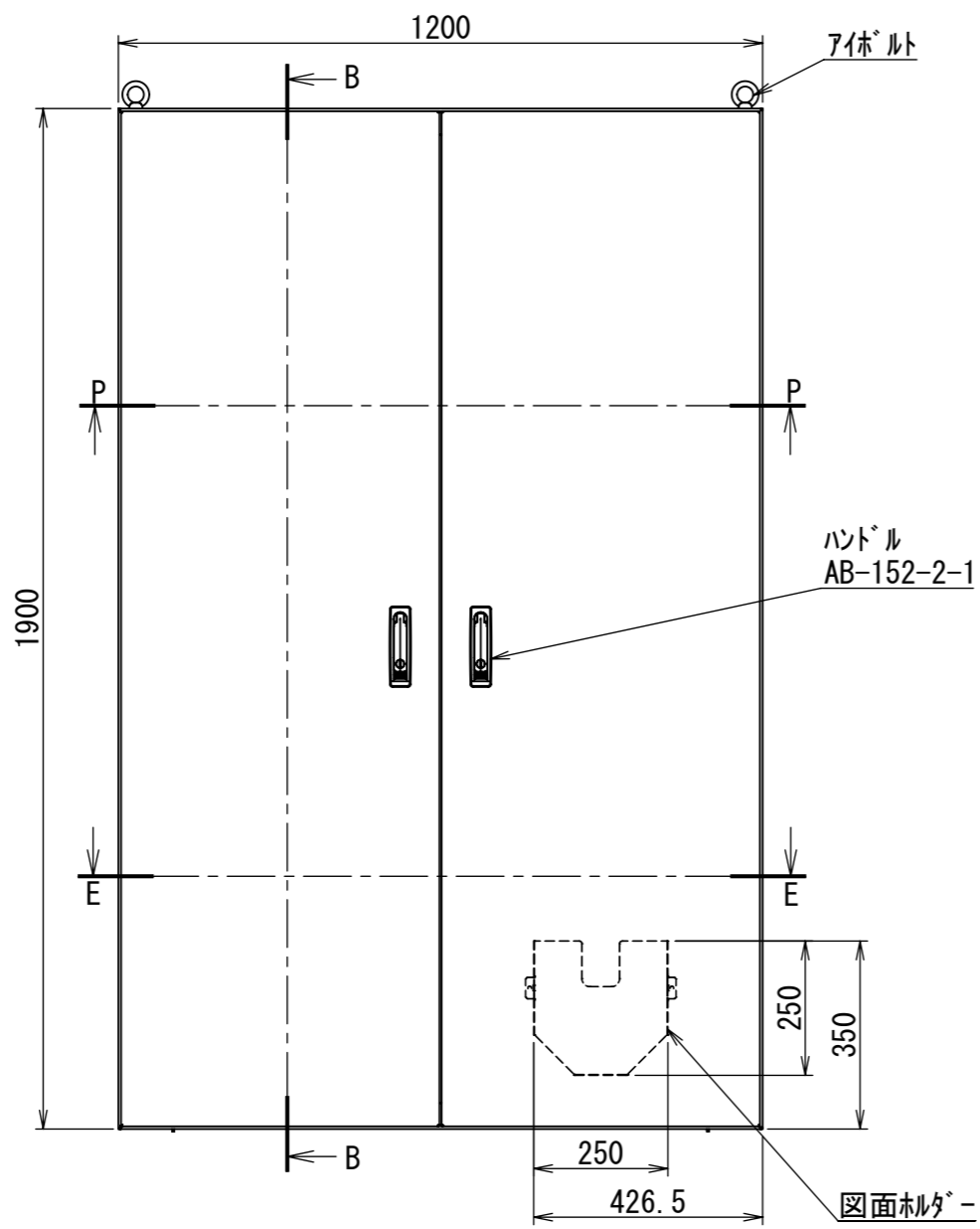
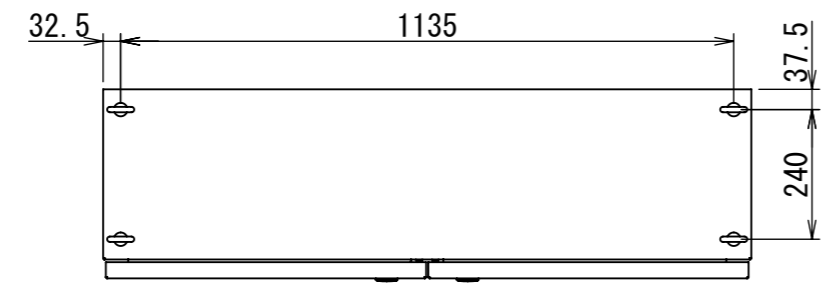

Note :
 材質 別途記載
 塗装 5Y7/1. 半ツヤ(標準色)

Designed by Yokogawa	Checked by -	Approved by - date -	Filename FEWP0000A00a	Date 21/10/27	Scale 1:14
エス・ディ・エス株式会社			自立制御盤/FE35-1219WP		
			FEWP0000A00	Edition A	Sheet 1/2

2021/12/02

2021/12/02

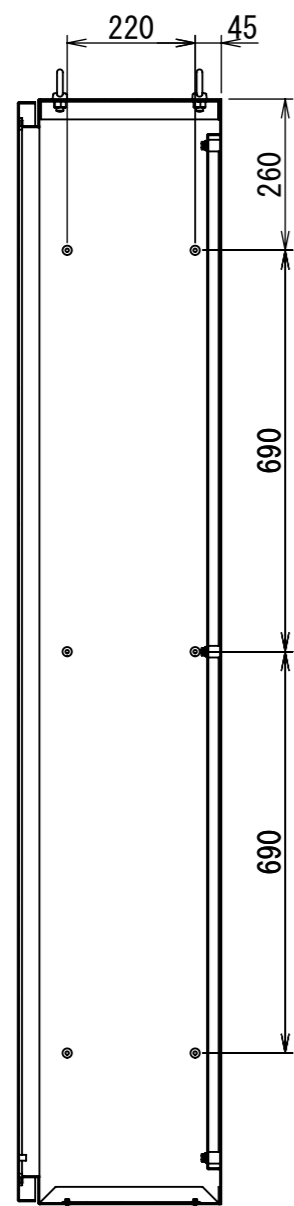

断面図 B-B

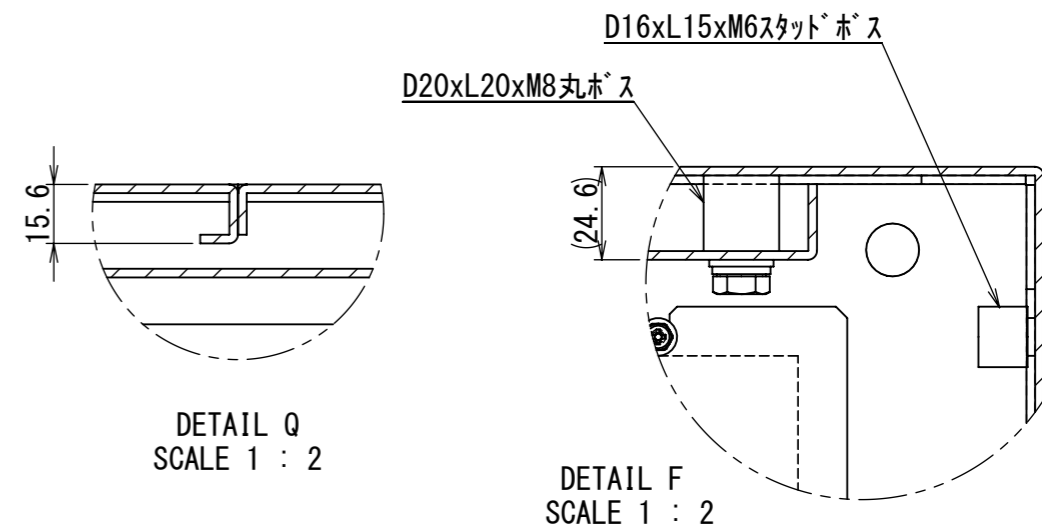
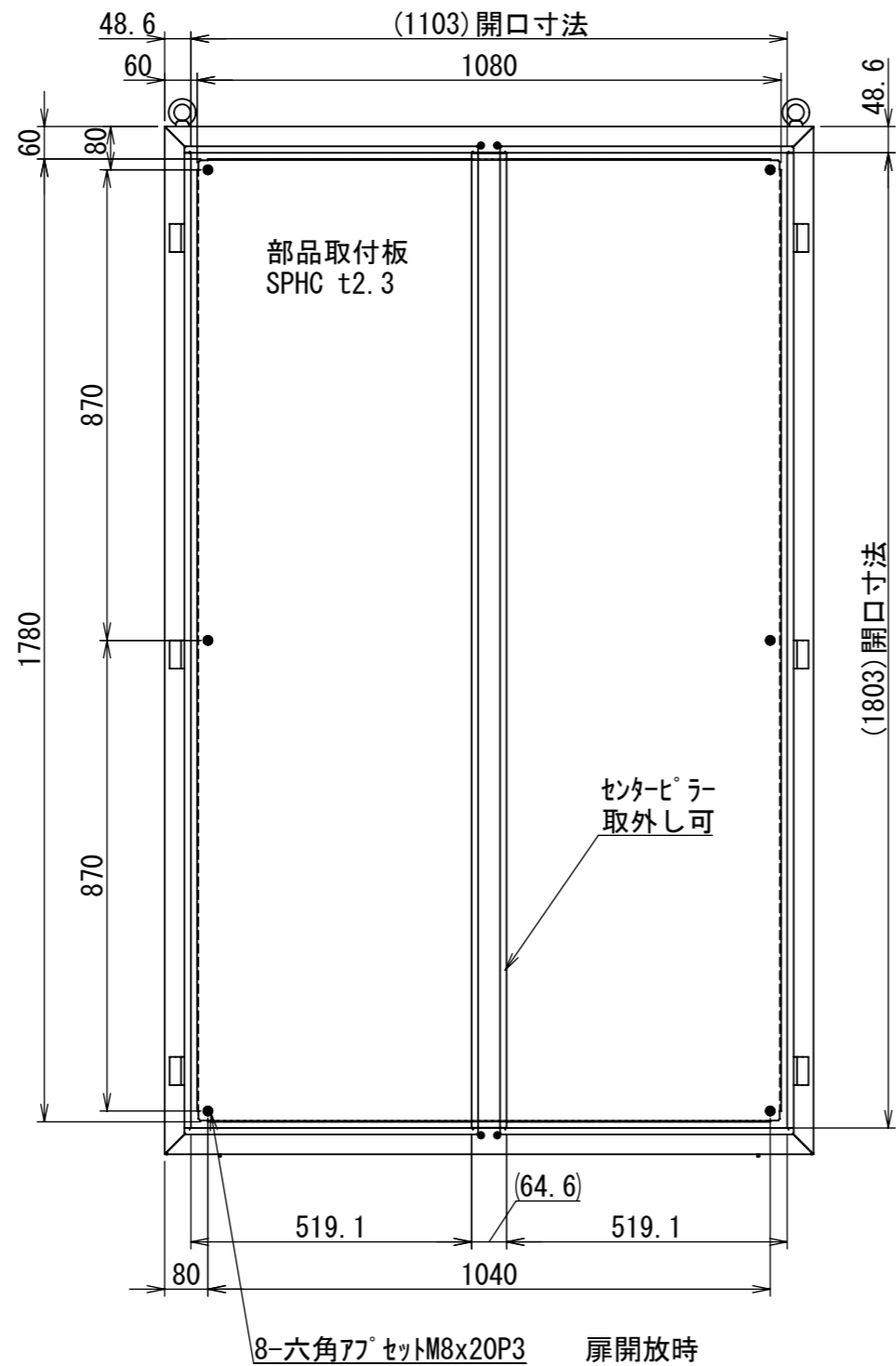

DETAIL Q
SCALE 1 : 2

DETAIL F
SCALE 1 : 2

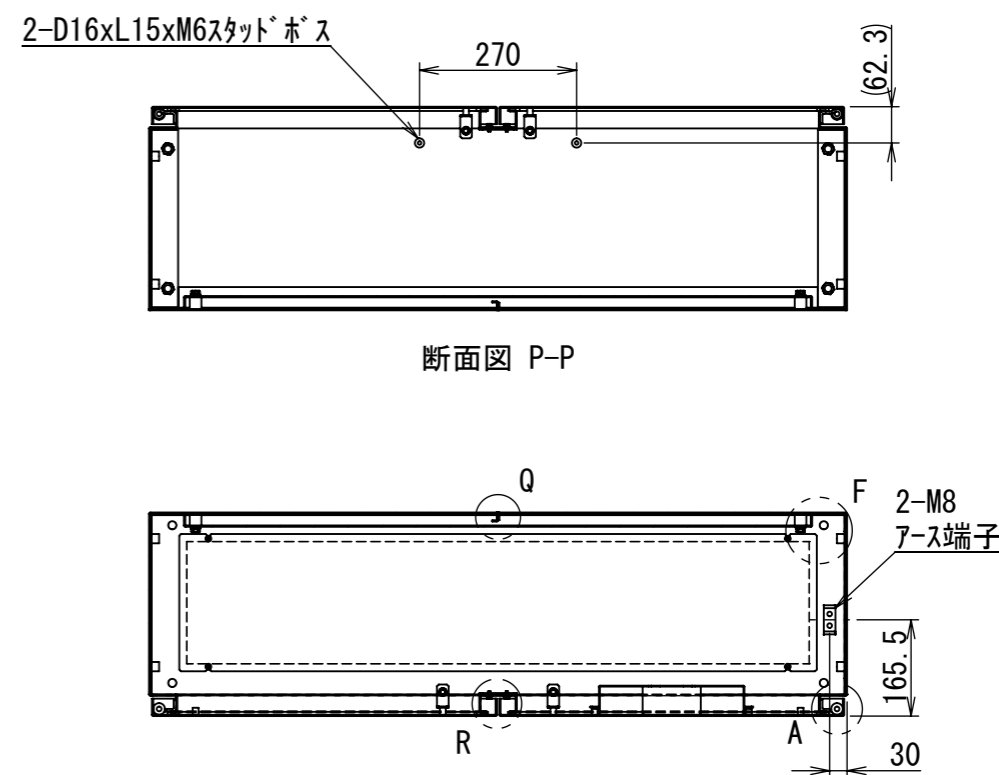

断面図 P-P

断面図 E-E

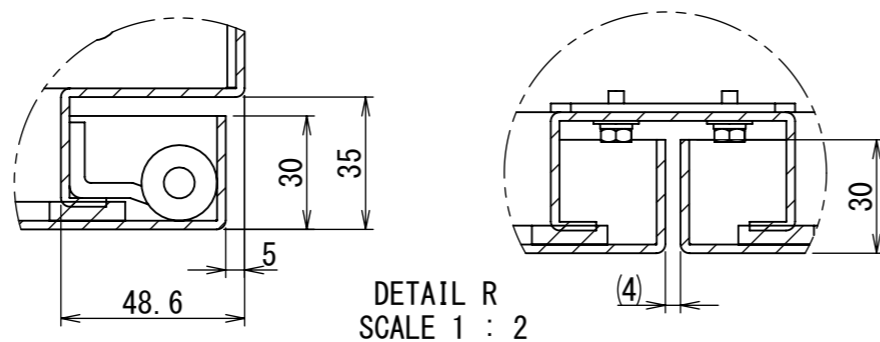

DETAIL A
SCALE 1 : 2

DETAIL R
SCALE 1 : 2

Note :
材質 別途記載
塗装 5Y7/1. 半ツヤ(標準色)

Designed by Yokogawa	Checked by -	Approved by - date -	Filename FEWP0000A00a	Date 21/10/27	Scale 1:13
エス・ディ・エス株式会社			自立制御盤/FE35-1219WP		
			FEWP0000A00	Edition A	Sheet 2/2