

REV.	DESCRIPTION	DATE	APPVL.
A	新規作成		

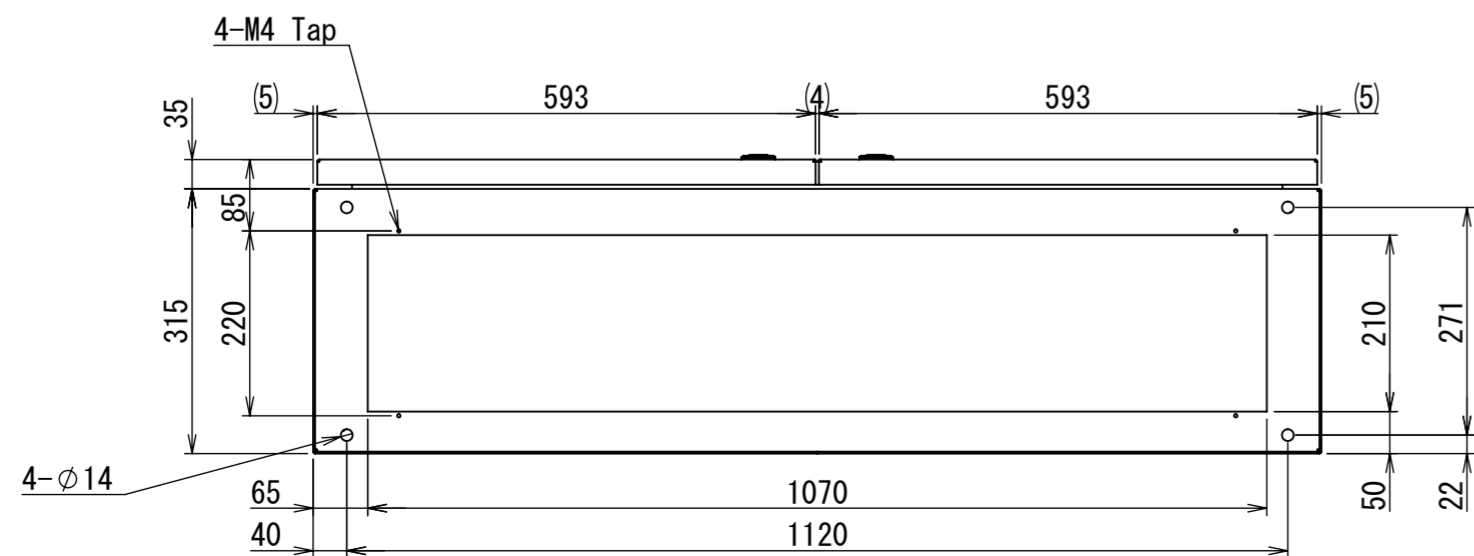
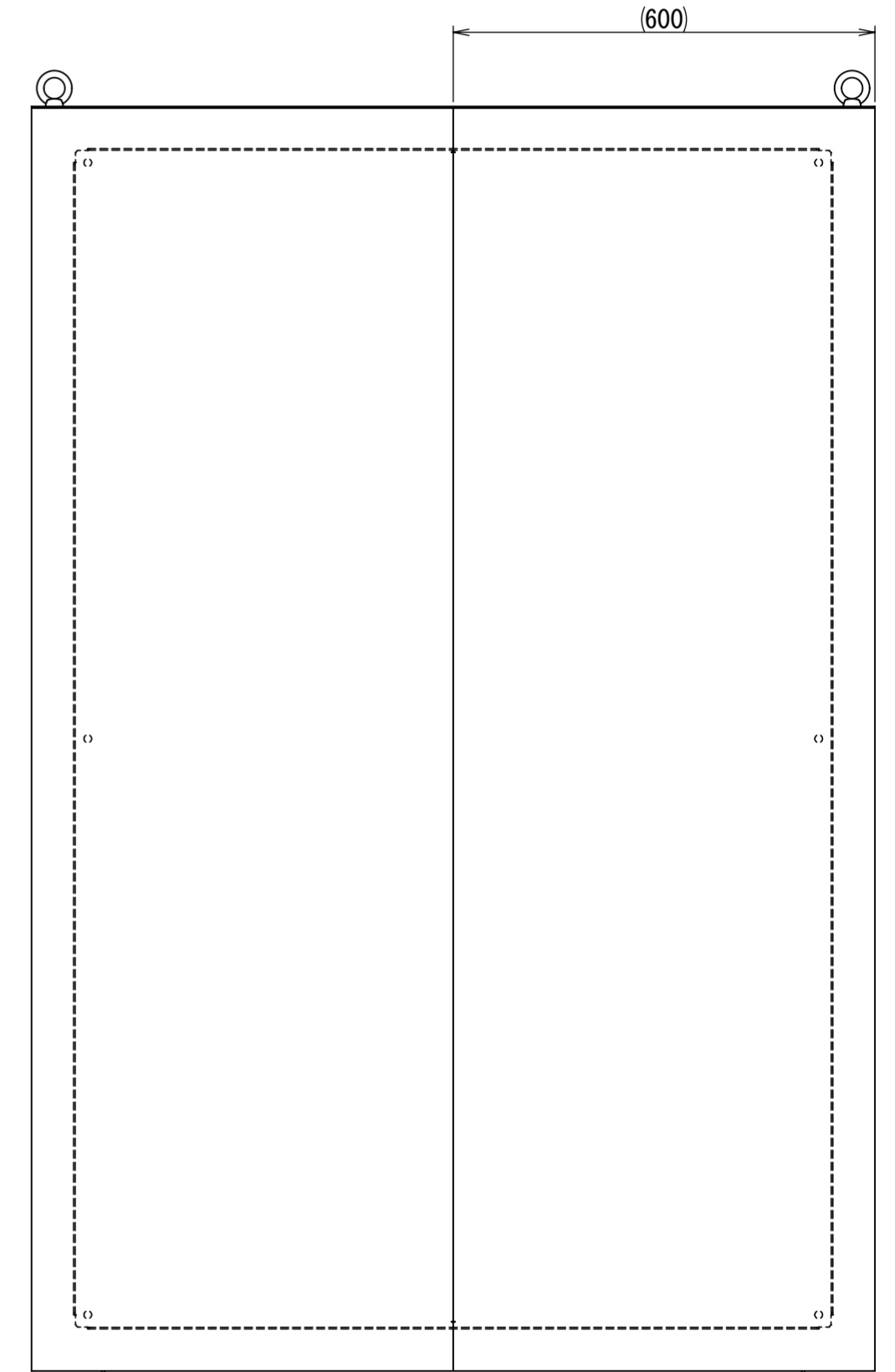
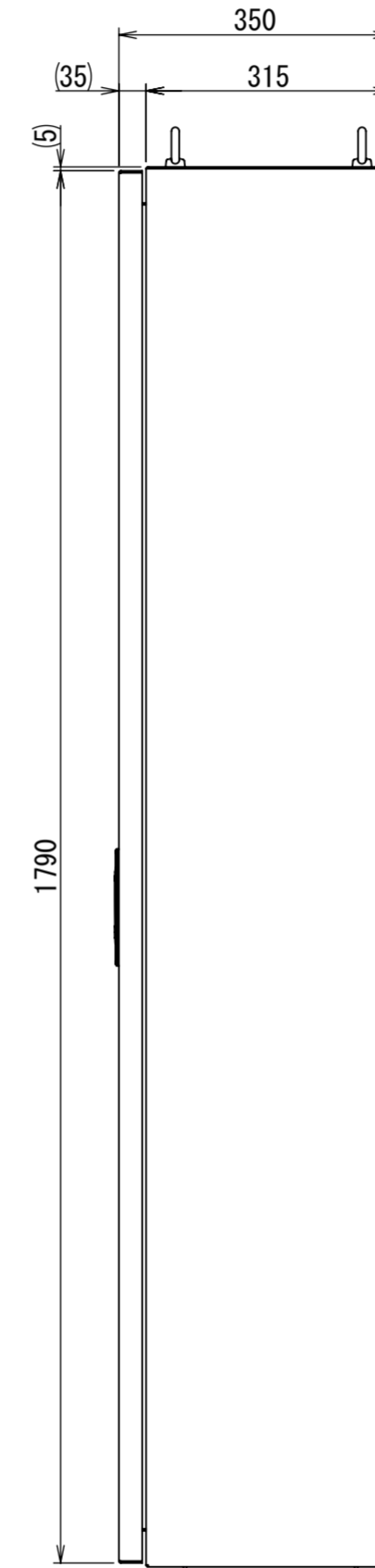
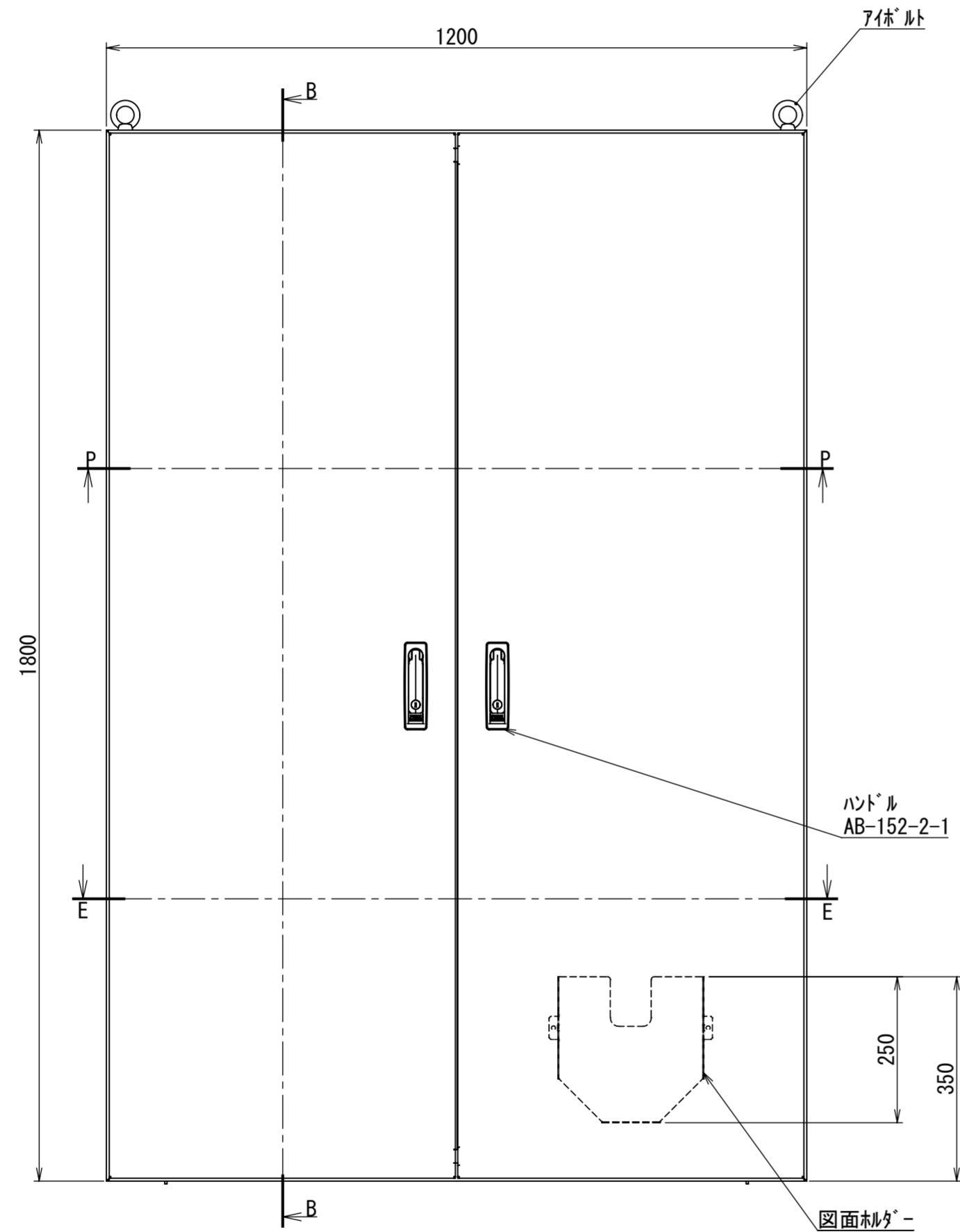
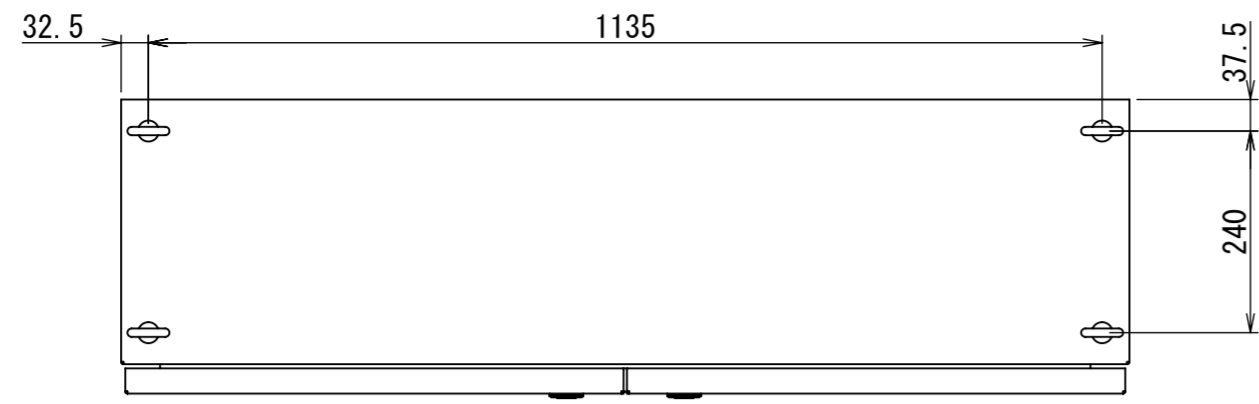

Note :
 材質 別途記載
 塗装 5Y7/1. 半ツヤ(標準色)

Designed by Yokogawa	Checked by -	Approved by - date -	Filename FEW0000A00a	Date -	Scale 1:9
エス・ディ・エス株式会社			自立制御盤/FE35-1218W		
			FEW399A00	Edition A	Sheet 1/2

2021/10/26

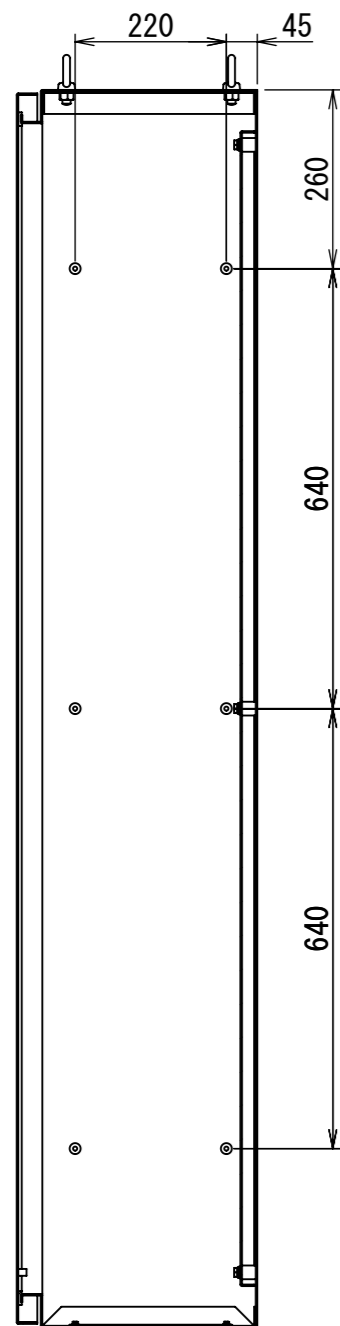

断面図 B-B

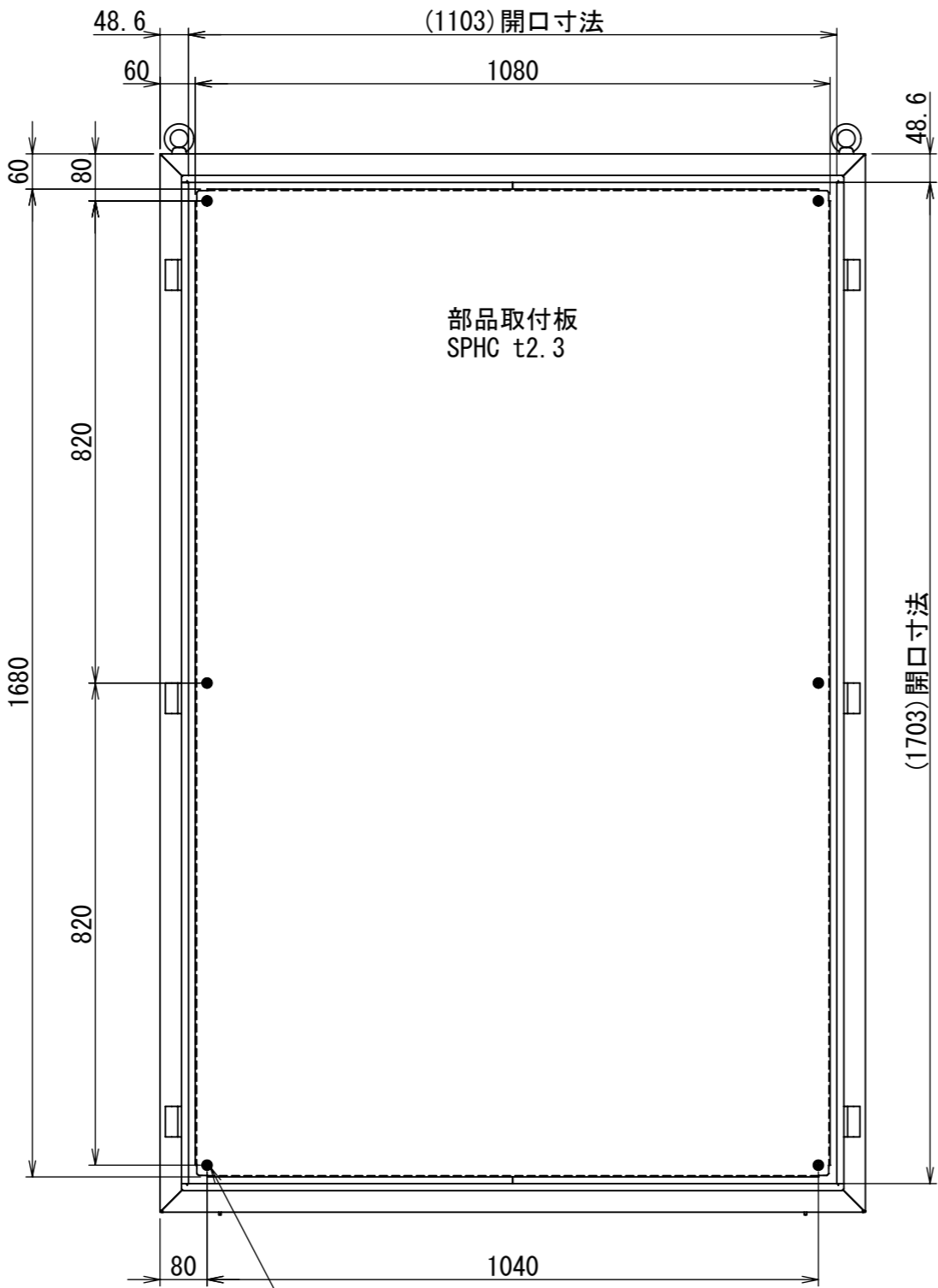

8-六角7°セットM8x20P3 扉開放時

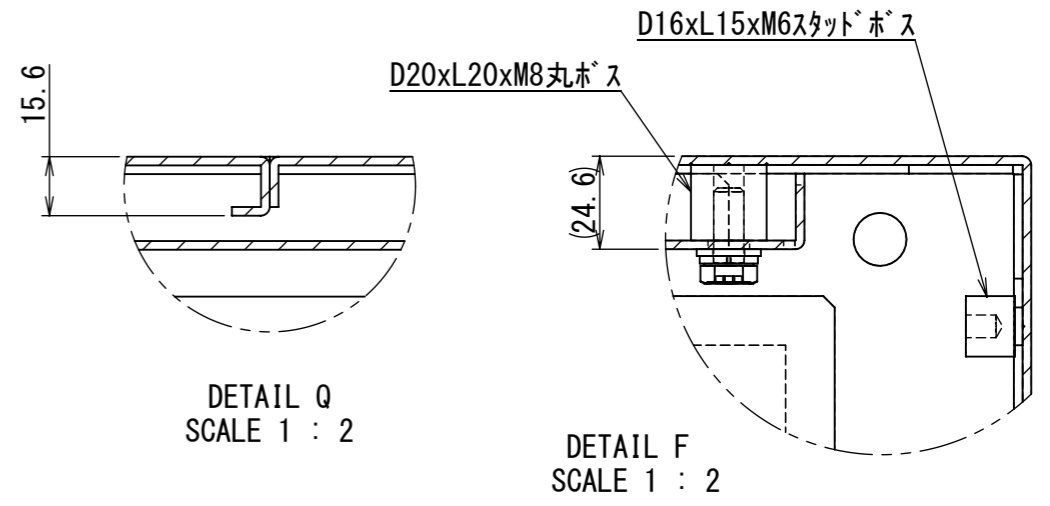

DETAIL Q
SCALE 1 : 2

DETAIL F
SCALE 1 : 2

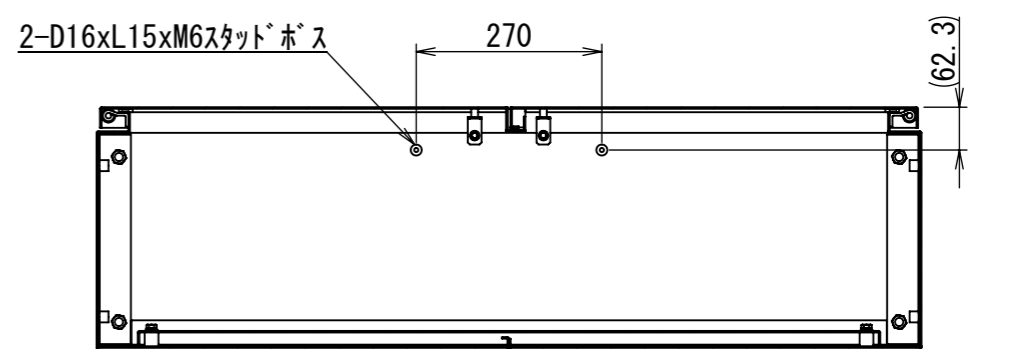

断面図 P-P

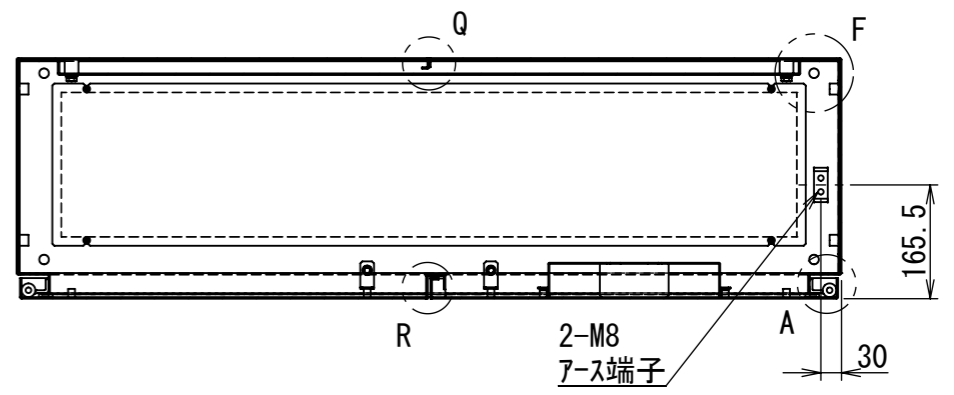

断面図 E-E

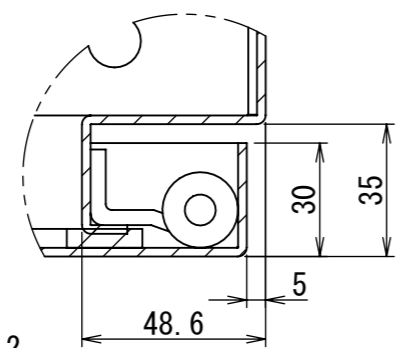

DETAIL A
SCALE 1 : 2

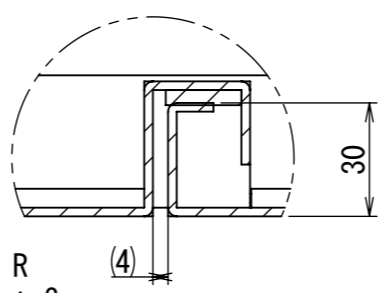

DETAIL R
SCALE 1 : 2

Note :
材質 別途記載
塗装 5Y7/1.半ツヤ(標準色)

Designed by Yokogawa	Checked by -	Approved by - date -	Filename FEW0000A00a	Date -	Scale 1:11
エス・ディ・エス株式会社			自立制御盤/FE35-1218W		
			FEW399A00	Edition A	Sheet 2/2