

REV.	DESCRIPTION	DATE	APPL.
A	新規作成	21/10/27	

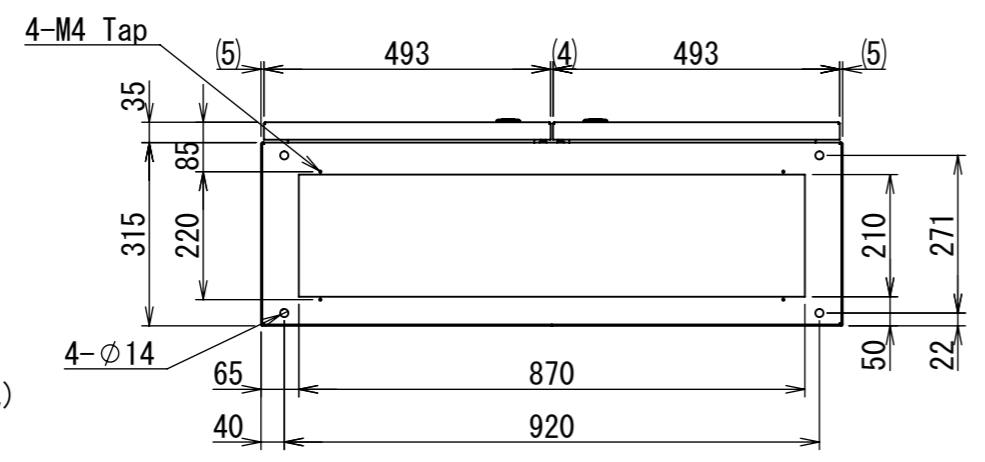
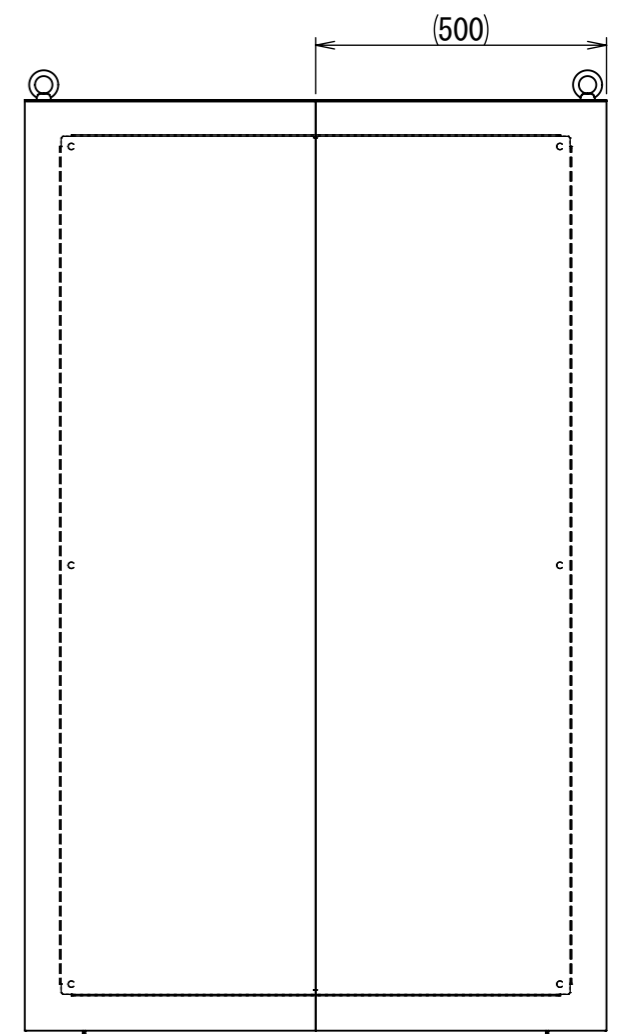
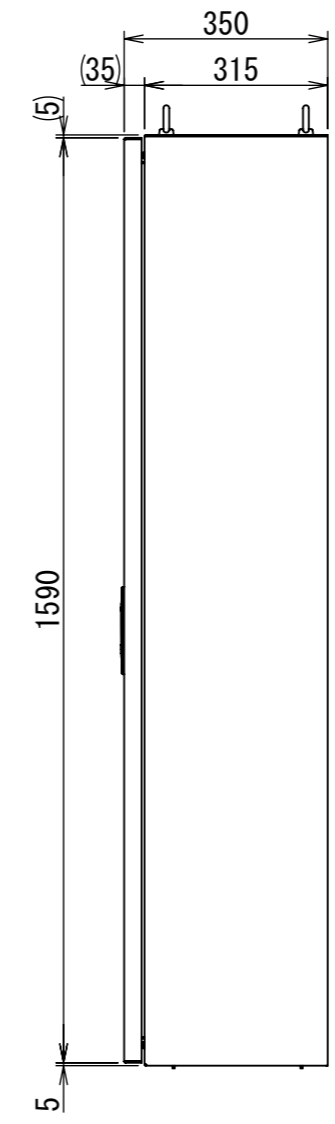
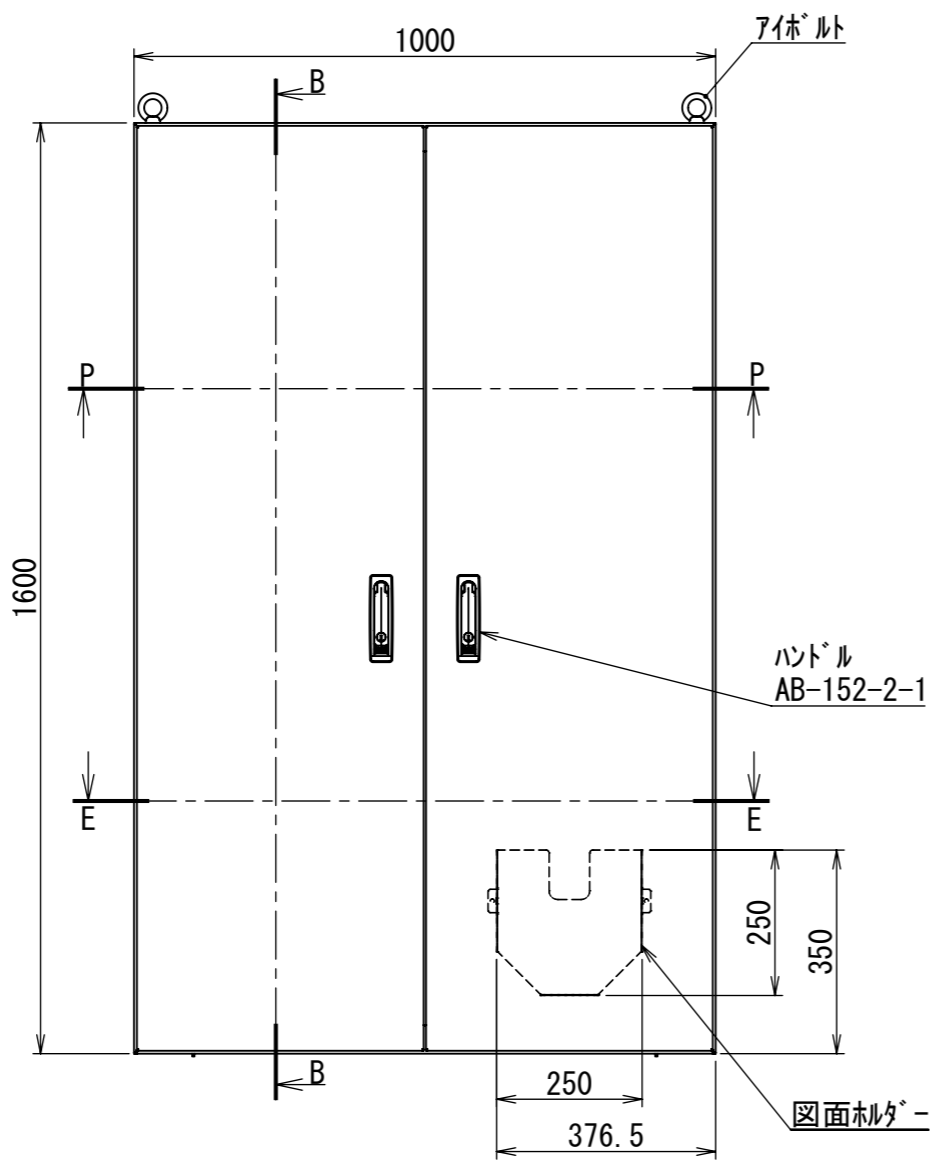
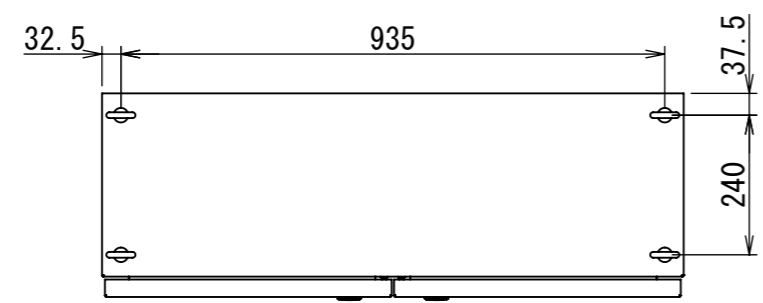

Note :  
 材質 別途記載  
 塗装 5Y7/1. 半ツヤ(標準色)

Designed by Yokogawa	Checked by -	Approved by - date -	Filename FEWP0000A00a	Date 21/10/27	Scale 1:13
エス・ディ・エス株式会社			自立制御盤/FE35-1016WP		
			FEWP0000A00	Edition A	Sheet 1/2

2021/11/30

1 2 3 4 5 6 7 8

A  
B  
C  
D  
E  
F

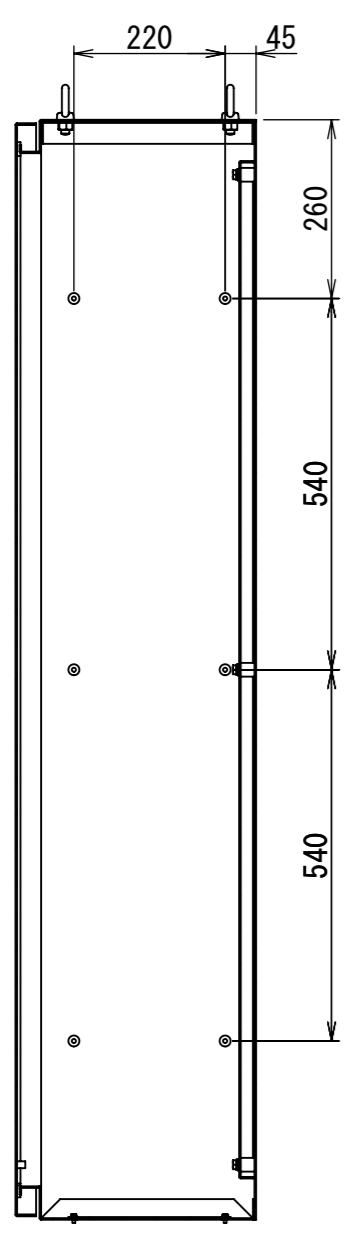

断面図 B-B

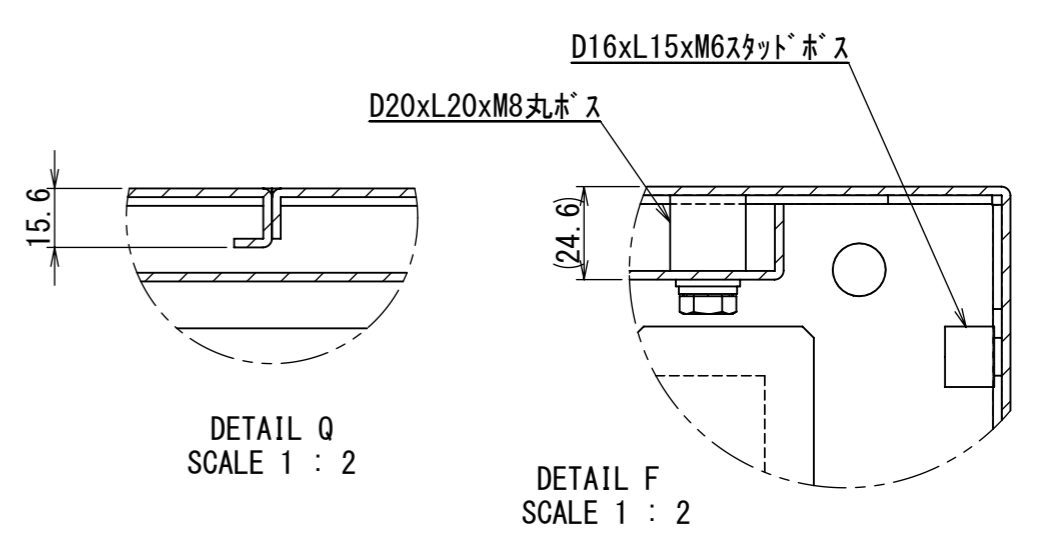
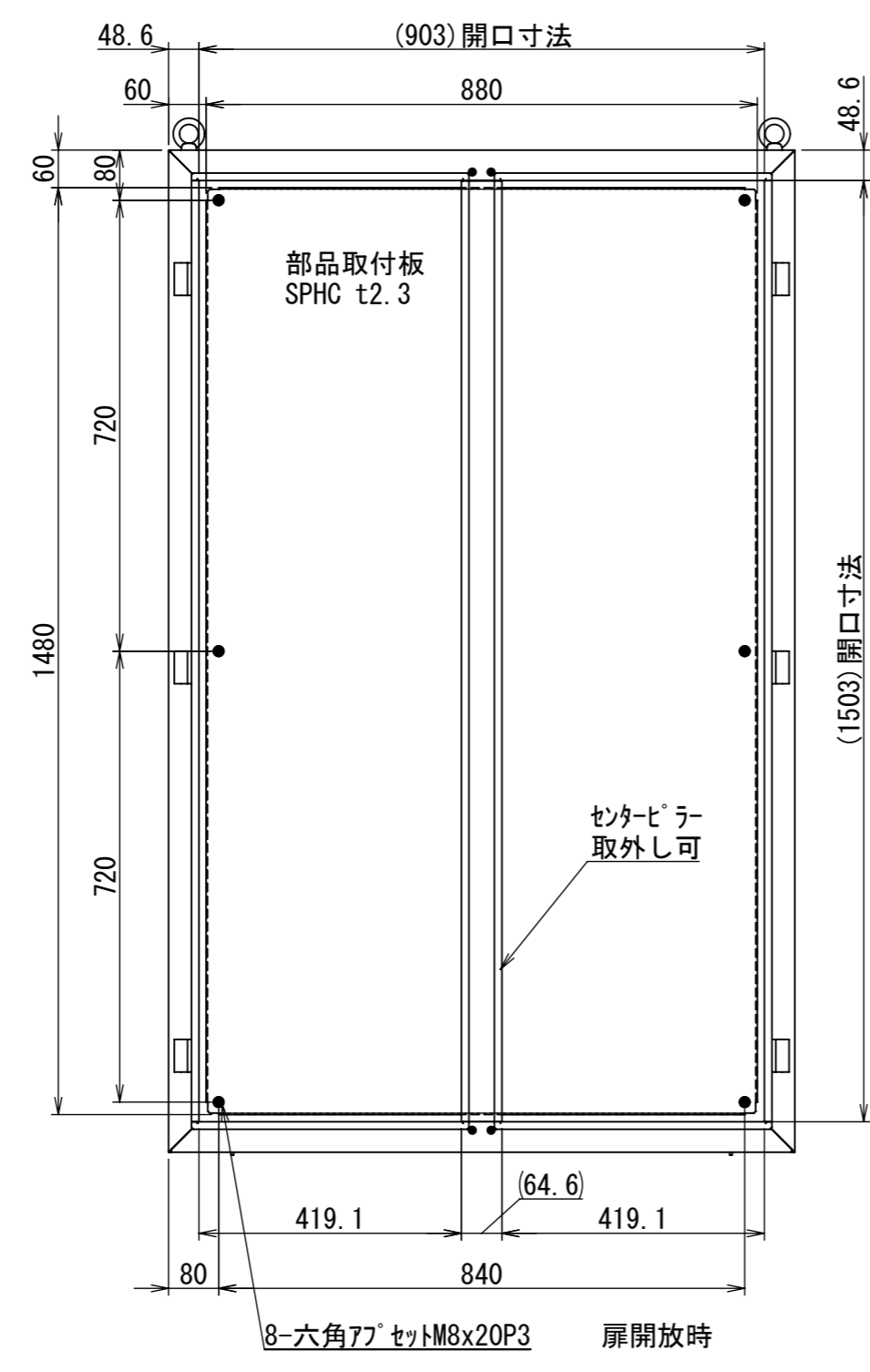

DETAIL Q  
SCALE 1 : 2

DETAIL F  
SCALE 1 : 2

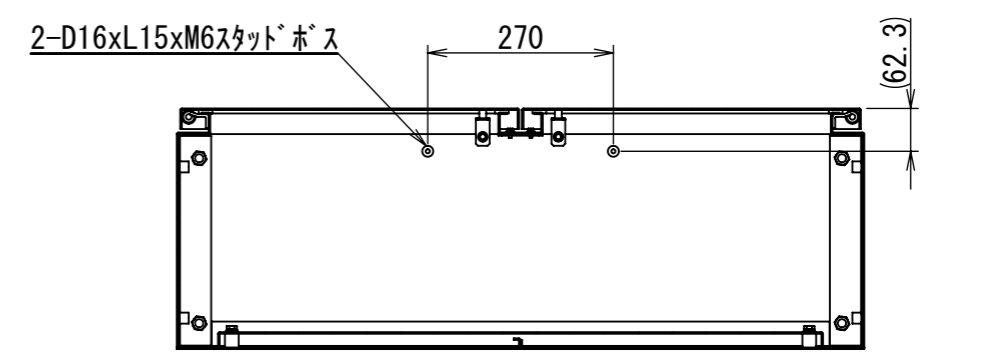

断面図 P-P

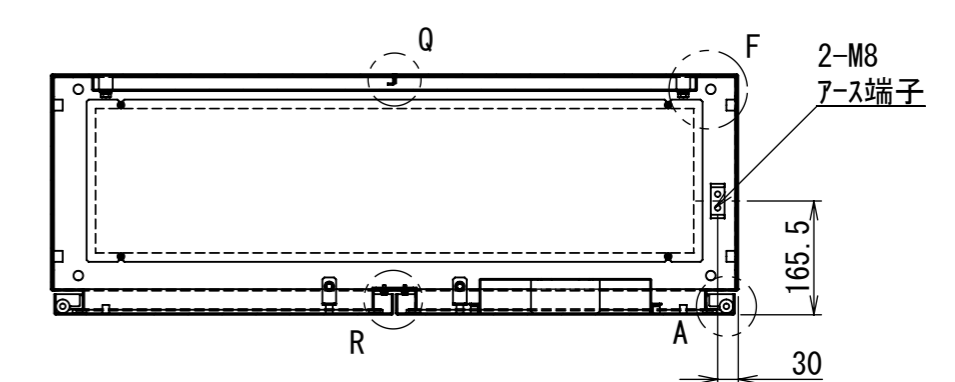

断面図 E-E

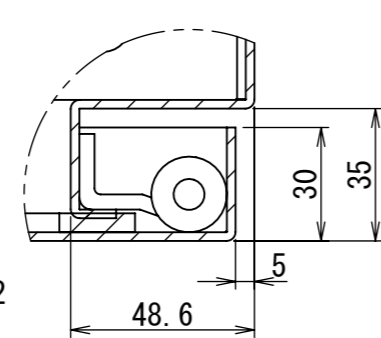

DETAIL A  
SCALE 1 : 2

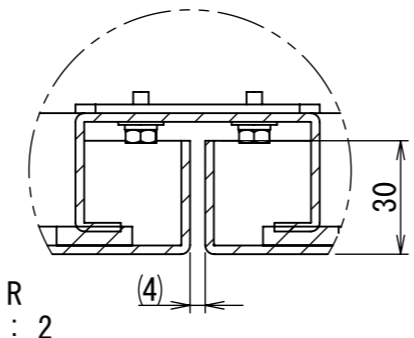

DETAIL R  
SCALE 1 : 2

Note :  
材質 別途記載  
塗装 5Y7/1. 半ツヤ(標準色)

Designed by Yokogawa	Checked by -	Approved by - date -	Filename FEWP0000A00a	Date 21/10/27	Scale 1:11
エス・ディ・エス株式会社			自立制御盤/FE35-1016WP		
			FEWP0000A00	Edition A	Sheet 2/2

2021/11/30

1 2 3 4 5 6 7 8