

A  
B  
C  
D  
E  
F

A  
B  
C  
D  
E  
F

2019/05/24

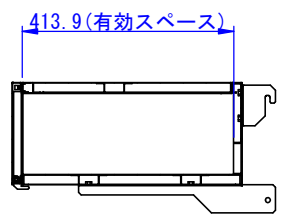
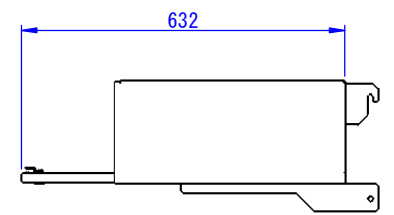
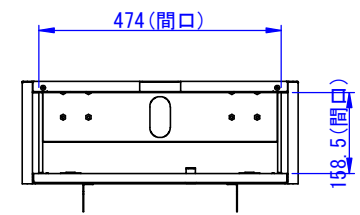
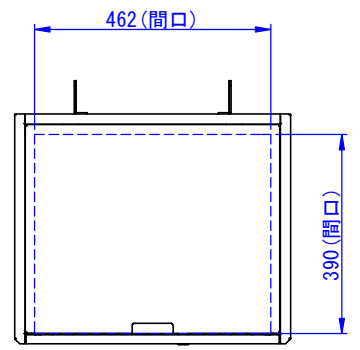
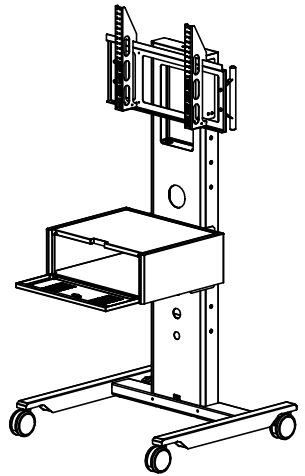

断面図 A-A

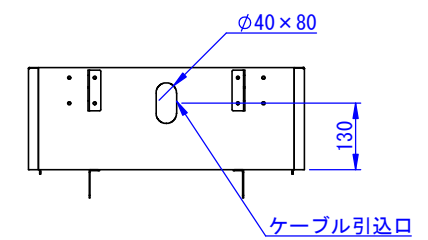
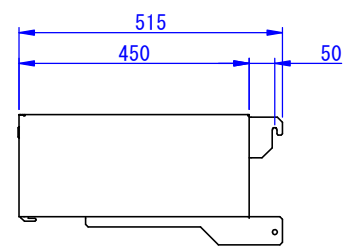
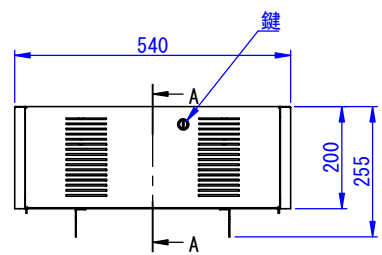

表面処理：  
サンブラック

Designed by K.Kitamura	Checked by _	Approved by - date _	Filename _	Date 19/05/24	Scale 1:10
エス・ディ・エス株式会社			OP-BX02		
			SDDV126G2001	Edition -	Sheet 1/1